

Process Pump

## CPKN

Complementary Sizes  
Bearing Assemblies P08s, P10as, P12s

## Installation/Operating Manual



**KSb. IRAN**

**[www.ksbiran.com](http://www.ksbiran.com)**

**Contents**

	<b>Glossary .....</b>	<b>6</b>
<b>1</b>	<b>General.....</b>	<b>7</b>
	1.1 Principles .....	7
	1.2 Installation of partly completed machinery.....	7
	1.3 Target group.....	7
	1.4 Other applicable documents.....	7
	1.5 Symbols .....	7
	1.6 Key to safety symbols/markings.....	8
<b>2</b>	<b>Safety .....</b>	<b>9</b>
	2.1 General.....	9
	2.2 Intended use .....	9
	2.3 Personnel qualification and training.....	9
	2.4 Consequences and risks caused by non-compliance with this manual .....	10
	2.5 Safety awareness .....	10
	2.6 Safety information for the operator/user .....	10
	2.7 Safety information for maintenance, inspection and installation .....	10
	2.8 Unauthorised modes of operation .....	11
	2.9 Explosion protection .....	11
	2.9.1 Marking .....	11
	2.9.2 Temperature limits.....	11
	2.9.3 Monitoring equipment.....	12
	2.9.4 Operating limits .....	12
<b>3</b>	<b>Transport/Temporary Storage/Disposal.....</b>	<b>13</b>
	3.1 Checking the condition upon delivery .....	13
	3.2 Transport.....	13
	3.3 Storage/preservation .....	14
	3.4 Return to supplier.....	14
	3.5 Disposal .....	15
<b>4</b>	<b>Description of the Pump (Set) .....</b>	<b>16</b>
	4.1 General description .....	16
	4.2 Designation.....	16
	4.3 Name plate.....	16
	4.4 Design details.....	16
	4.5 Design and function.....	18
	4.6 Noise characteristics .....	19
	4.7 Scope of supply.....	19
	4.8 Dimensions and weights .....	20
<b>5</b>	<b>Installation at Site .....</b>	<b>21</b>
	5.1 Safety regulations.....	21
	5.2 Checks to be carried out prior to installation.....	21
	5.3 Installing the pump set .....	21
	5.3.1 Installation on the foundation.....	22
	5.4 Piping .....	23
	5.4.1 Connecting the piping.....	23
	5.4.2 Permissible forces and moments at the pump nozzles.....	24
	5.4.3 Auxiliary connections.....	25
	5.5 Enclosure/insulation .....	26
	5.6 Checking the coupling alignment .....	26
	5.7 Aligning the pump and motor .....	27
	5.8 Electrical connection .....	28
	5.8.1 Setting the time relay .....	29
	5.8.2 Earthing.....	29

5.8.3	Connecting the motor .....	29
5.9	Checking the direction of rotation.....	30
<b>6</b>	<b>Commissioning/Start-up/Shutdown. ....</b>	<b>31</b>
6.1	Commissioning/Start-up.....	31
6.1.1	Prerequisites for commissioning/start-up .....	31
6.1.2	Filling in lubricants.....	31
6.1.3	Shaft seal .....	32
6.1.4	Priming and venting the pump.....	33
6.1.5	Final check.....	33
6.1.6	Water cooling.....	33
6.1.7	Cooling of the shaft seal ("K" design).....	34
6.1.8	Bearing bracket cooling .....	34
6.1.9	Heating up/keeping warm the pump (set).....	34
6.1.10	Start-up.....	35
6.1.11	Checking the shaft seal.....	36
6.1.12	Shutdown .....	37
6.2	Operating limits.....	37
6.2.1	Ambient temperature.....	38
6.2.2	Frequency of starts.....	38
6.2.3	Fluid handled .....	38
6.3	Shutdown/storage/preservation .....	39
6.3.1	Measures to be taken for shutdown .....	39
6.4	Returning to service .....	40
<b>7</b>	<b>Servicing/Maintenance.....</b>	<b>41</b>
7.1	Safety regulations.....	41
7.2	Servicing/Maintenance .....	42
7.2.1	Supervision of operation .....	42
7.2.2	Inspection work.....	44
7.2.3	Lubrication and lubricant change of rolling element bearings .....	45
7.3	Drainage/cleaning .....	46
7.4	Dismantling the pump set.....	47
7.4.1	General information/Safety regulations.....	47
7.4.2	Preparing the pump set.....	47
7.4.3	Removing the motor.....	48
7.4.4	Removing the back pull-out unit .....	48
7.4.5	Removing the impeller .....	48
7.4.6	Removing the shaft seal .....	49
7.4.7	Dismantling the bearings .....	50
7.5	Reassembling the pump set .....	50
7.5.1	General information/Safety regulations.....	50
7.5.2	Installing the bearings.....	51
7.5.3	Fitting the shaft seal .....	52
7.5.4	Fitting the impeller .....	54
7.5.5	Fitting the back pull-out unit.....	55
7.5.6	Mounting the motor .....	55
7.6	Tightening torques.....	56
7.6.1	Tightening torques .....	56
7.6.2	Tightening torques for impeller nut/impeller screw .....	56
7.7	Spare parts stock.....	56
7.7.1	Ordering spare parts.....	56
7.7.2	Recommended spare parts stock for 2 years' operation to DIN 24296 .....	57
7.7.3	Interchangeability of pump components.....	58
<b>8</b>	<b>Trouble-shooting.....</b>	<b>59</b>
<b>9</b>	<b>Related Documents .....</b>	<b>61</b>
9.1	General assembly drawing with list of components .....	61

10	EU Declaration of Conformity .....	63
11	Certificate of Decontamination.....	64
	Index .....	65

## Glossary

### **Back pull-out design**

The complete back pull-out unit can be pulled out without having to remove the pump casing from the piping.

### **Back pull-out unit**

Pump without pump casing; partly completed machinery

### **Certificate of decontamination**

A certificate of decontamination is enclosed by the customer when returning the product to the manufacturer to certify that the product has been properly drained to eliminate any environmental and health hazards arising from components in contact with the fluid handled.

### **Discharge line**

The pipeline which is connected to the discharge nozzle

### **Hydraulic system**

The part of the pump in which the kinetic energy is converted into pressure energy

### **Pool of pumps**

Customers/operators' pumps which are purchased and stored regardless of their later use.

### **Pump**

Machine without drive, additional components or accessories

### **Pump set**

Complete pump set consisting of pump, drive, additional components and accessories

### **Suction lift line/suction head line**

The pipeline which is connected to the suction nozzle

## 1 General

### 1.1 Principles

This operating manual is valid for the type series and variants indicated on the front cover.

The manual describes the proper and safe use of this equipment in all phases of operation.

The name plate indicates the type series and size, the main operating data, the order number and the order item number. The order number and order item number clearly identify the pump set and serve as identification for all further business processes.

In the event of damage, immediately contact your nearest KSB Service centre to maintain the right to claim under warranty.

### 1.2 Installation of partly completed machinery

To install partly completed machinery supplied by KSB refer to the sub-sections under Servicing/Maintenance. (⇒ Section 7.5.5, Page 55)

### 1.3 Target group

This operating manual is aimed at the target group of trained and qualified specialist technical personnel. (⇒ Section 2.3, Page 9)

### 1.4 Other applicable documents

**Table 1:** Overview of other applicable documents

Document	Contents
Data sheet	Description of the technical data of the pump (set)
General arrangement drawing/ outline drawing	Description of mating and installation dimensions for the pump (set), weights
Drawing of auxiliary connections	Description of auxiliary connections
Hydraulic characteristic curve	Characteristic curves showing head, NPSH required, efficiency and power input
General assembly drawing <sup>1)</sup>	Sectional drawing of the pump
Sub-supplier product literature <sup>1)</sup>	Operating manuals and other product literature describing accessories and integrated machinery components
Spare parts lists <sup>1)</sup>	Description of spare parts
Piping layout <sup>1)</sup>	Description of auxiliary piping
List of components <sup>1)</sup>	Description of all pump components
Drawing for assembly <sup>1)</sup>	Sectional drawing of the installed shaft seal

For accessories and/or integrated machinery components observe the relevant manufacturer's product literature.

### 1.5 Symbols

**Table 2:** Symbols used in this manual







Symbol	Description
✓	Conditions which need to be fulfilled before proceeding with the step-by-step instructions
▷	Safety instructions
⇒	Result of an action
⇔	Cross-references

1) If agreed upon in scope of supply

Symbol	Description
1. 2.	Step-by-step instructions
	Note Recommendations and important information on how to handle the product

### 1.6 Key to safety symbols/markings

Table 3: Definition of safety symbols/markings

Symbol	Description
 <b>DANGER</b>	<b>DANGER</b> This signal word indicates a high-risk hazard which, if not avoided, will result in death or serious injury.
 <b>WARNING</b>	<b>WARNING</b> This signal word indicates a medium-risk hazard which, if not avoided, could result in death or serious injury.
<b>CAUTION</b>	<b>CAUTION</b> This signal word indicates a hazard which, if not avoided, could result in damage to the machine and its functions.
	<b>Explosion protection</b> This symbol identifies information about avoiding explosions in potentially explosive atmospheres in accordance with EU Directive 2014/34/EU (ATEX).
	<b>General hazard</b> In conjunction with one of the signal words this symbol indicates a hazard which will or could result in death or serious injury.
	<b>Electrical hazard</b> In conjunction with one of the signal words this symbol indicates a hazard involving electrical voltage and identifies information about protection against electrical voltage.
	<b>Machine damage</b> In conjunction with the signal word CAUTION this symbol indicates a hazard for the machine and its functions.





## 2 Safety

All the information contained in this section refers to hazardous situations.

In addition to the present general safety information the action-related safety information given in the other sections must be observed.

### 2.1 General

This operating manual contains general installation, operating and maintenance instructions that must be observed to ensure safe operation of the system and prevent personal injury and damage to property.

The safety information in all sections of this manual must be complied with.

The operating manual must be read and understood by the responsible specialist personnel/operators prior to installation and commissioning.

The contents of this operating manual must be available to the specialist personnel at the site at all times.

Information attached directly to the product must always be complied with and kept in a perfectly legible condition at all times. This applies to, for example:

- Arrow indicating the direction of rotation
- Markings for connections
- Name plate

The operator is responsible for ensuring compliance with all local regulations not taken into account in this operating manual.

### 2.2 Intended use

- The pump (set) must only be operated in the fields of application and within the use limits specified in the other applicable documents. (⇒ Section 1.4, Page 7)
- Only operate pumps/pump sets which are in perfect technical condition.
- Do not operate the pump (set) in partially assembled condition.
- Only use the pump to handle the fluids described in the data sheet or product literature of the pump model or variant.
- Never operate the pump without the fluid to be handled.
- Observe the minimum flow rates indicated in the data sheet or product literature (to prevent overheating, bearing damage, etc).
- Observe the minimum flow rate and maximum flow rate indicated in the data sheet or product literature (to prevent overheating, mechanical seal damage, cavitation damage, bearing damage, etc).
- Do not throttle the flow rate on the suction side of the pump (to prevent cavitation damage).
- Consult the manufacturer about any use or mode of operation not described in the data sheet or product literature.

### 2.3 Personnel qualification and training

All personnel involved must be fully qualified to transport, install, operate, maintain and inspect the machinery this manual refers to.

The responsibilities, competence and supervision of all personnel involved in transport, installation, operation, maintenance and inspection must be clearly defined by the operator.

Deficits in knowledge must be rectified by means of training and instruction provided by sufficiently trained specialist personnel. If required, the operator can commission the manufacturer/supplier to train the personnel.

Training on the pump (set) must always be supervised by technical specialist personnel.

### 2.4 Consequences and risks caused by non-compliance with this manual

- Non-compliance with these operating instructions will lead to forfeiture of warranty cover and of any and all rights to claims for damages.
- Non-compliance can, for example, have the following consequences:
  - Hazards to persons due to electrical, thermal, mechanical and chemical effects and explosions
  - Failure of important product functions
  - Failure of prescribed maintenance and servicing practices
  - Hazard to the environment due to leakage of hazardous substances

### 2.5 Safety awareness

In addition to the safety information contained in this manual and the intended use, the following safety regulations shall be complied with:

- Accident prevention, health regulations and safety regulations
- Explosion protection regulations
- Safety regulations for handling hazardous substances
- Applicable standards, directives and laws

### 2.6 Safety information for the operator/user

- Fit protective equipment (e.g. contact guards) supplied by the operator for hot, cold or moving parts, and check that the equipment functions properly.
- Do not remove any protective equipment (e.g. contact guards) during operation.
- Provide the personnel with protective equipment and make sure it is used.
- Contain leakages (e.g. at the shaft seal) of hazardous fluids handled (e.g. explosive, toxic, hot) so as to avoid any danger to persons and the environment. Adhere to all relevant laws.
- Eliminate all electrical hazards. (In this respect refer to the applicable national safety regulations and/or regulations issued by the local energy supply companies.)
- If shutting down the pump does not increase potential risk, fit an emergency-stop control device in the immediate vicinity of the pump (set) during pump set installation.

### 2.7 Safety information for maintenance, inspection and installation

- Modifications or alterations of the pump (set) are only permitted with the manufacturer's prior consent.
- Use only original spare parts or parts/components authorised by the manufacturer. The use of other parts/components can invalidate any liability of the manufacturer for resulting damage.
- The operator ensures that maintenance, inspection and installation is performed by authorised, qualified specialist personnel who are thoroughly familiar with the manual.
- Only carry out work on the pump (set) during standstill of the pump.
- Only perform work on the pump set when it has been disconnected from the power supply (de-energised).
- The pump (set) must have cooled down to ambient temperature.
- Pump pressure must have been released and the pump must have been drained.

- When taking the pump set out of service always adhere to the procedure described in the manual. (⇒ Section 6.1.12, Page 37) (⇒ Section 6.3, Page 39)
- Decontaminate pumps which handle fluids posing a health hazard. (⇒ Section 7.3, Page 46)
- As soon as the work has been completed, re-install and re-activate any safety-relevant devices and protective devices. Before returning the product to service, observe all instructions on commissioning. (⇒ Section 6.1, Page 31)

### 2.8 Unauthorised modes of operation

Never operate the pump (set) outside the limits stated in the data sheet and in this manual.

The warranty relating to the operating reliability and safety of the supplied pump (set) is only valid if the equipment is used in accordance with its intended use. (⇒ Section 2.2, Page 9)

### 2.9 Explosion protection



**Always observe the information on explosion protection given in this section when operating the product in potentially explosive atmospheres.**

Only pumps/pump sets marked as explosion-proof **and** identified as such in the data sheet may be used in potentially explosive atmospheres.

Special conditions apply to the operation of explosion-proof pump sets to EU Directive 2014/34/EU (ATEX).

Especially adhere to the sections in this manual marked with the symbol opposite and the following sections, (⇒ Section 2.9.1, Page 11) to (⇒ Section 2.9.4, Page 12)

The explosion-proof status of the pump set is only assured if the pump set is used in accordance with its intended use.

Never operate the pump set outside the limits stated in the data sheet and on the name plate.

Prevent impermissible modes of operation at all times.

#### 2.9.1 Marking

**Pump** The marking on the pump refers to the pump part only.

Example of such marking:

II 2 G c TX (EN 13463-1) or II 2G Ex h IIC T5-T1 Gb (ISO 80079-36)

Refer to the individual Temperature Limits table for the temperatures permitted for the individual pump variants.

The pump complies with the requirements of type of protection constructional safety "c" to ISO 80079-37.

**Shaft coupling** An EC manufacturer's declaration is required for the shaft coupling; the shaft coupling must be marked accordingly.

**Motor** The motor must be considered separately.

#### 2.9.2 Temperature limits

In normal pump operation, the highest temperatures are to be expected on the surface of the pump casing, at the shaft seal and in the bearing areas.

The surface temperature at the pump casing corresponds to the temperature of the fluid handled. If the pump is heated in addition, the operator of the system is responsible for observing the specified temperature class and fluid temperature (operating temperature).

The table below lists the temperature classes and the resulting theoretical temperature limits of the fluid handled (a potential temperature rise in the shaft seal area has been taken into account).

The temperature class specifies the maximum permissible temperature at the surface of the pump set during operation. For the permissible operating temperature of the pump in question refer to the data sheet.

**Table 4:** Temperature limits

Temperature class to EN 13463-1 or ISO 80079-36	Maximum permissible fluid temperature
T1	Maximum 400 °C <sup>2)</sup>
T2	280 °C
T3	185 °C
T4	120 °C
T5	85 °C
T6	Only after consultation with the manufacturer

**Temperature class T5** Based on an ambient temperature of 40 °C and proper maintenance and operation, compliance with temperature class T5 is warranted in the area of the rolling element bearings. If the ambient temperature exceeds 40 °C, contact the manufacturer.

**Temperature class T6** A special design is required to comply with the requirements of temperature class T6 in the bearing area.

Misuse, malfunctions or non-compliance with the instructions may result in substantially higher temperatures.

Misuse, malfunctions or non-compliance with the instructions may result in substantially higher temperatures.

If the pump is to be operated at a higher temperature, if there is no data sheet or if the pump is part of a pool of pumps, contact KSB for the maximum permissible operating temperature.

### 2.9.3 Monitoring equipment

The pump (set) must only be operated within the limits specified in the data sheet and on the name plate.

If the system operator cannot warrant compliance with these operating limits, appropriate monitoring devices must be used.

Check whether monitoring equipment is required to ensure that the pump set functions properly.

Contact KSB for further information about monitoring equipment.

### 2.9.4 Operating limits

The minimum flows indicated in (⇒ Section 6.2.3.1, Page 38) refer to water and water-like fluids handled. Longer operating periods with these fluids and at the flow rates indicated will not cause an additional increase in the temperatures at the pump surface. However, if the physical properties of the fluids handled are different from water, it is essential to check whether an additional heat build-up may occur and if the minimum flow rate must therefore be increased. The calculation formula in (⇒ Section 6.2.3.1, Page 38) can be used to check whether additional heat build-up may lead to a dangerous temperature increase at the pump surface.



2) Depending on the material variant

## 3 Transport/Temporary Storage/Disposal

### 3.1 Checking the condition upon delivery

1. On transfer of goods, check each packaging unit for damage.
2. In the event of in-transit damage, assess the exact damage, document it and notify KSB or the supplying dealer and the insurer about the damage in writing immediately.

### 3.2 Transport

	 <b>DANGER</b>
	<p><b>The pump (set) could slip out of the suspension arrangement</b>            Danger to life from falling parts!</p> <ul style="list-style-type: none"> <li>▷ Always transport the pump (set) in the specified position.</li> <li>▷ Never attach the suspension arrangement to the free shaft end or the motor eyebolt.</li> <li>▷ Observe the information about weights, centre of gravity and fastening points.</li> <li>▷ Observe the applicable local accident prevention regulations.</li> <li>▷ Use suitable, permitted lifting accessories, e.g. self-tightening lifting tongs.</li> </ul>

To transport the pump/pump set or back pull-out unit suspend it from the lifting tackle as shown.

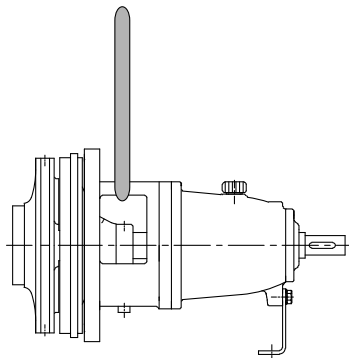

Fig. 1: Transporting the back pull-out unit

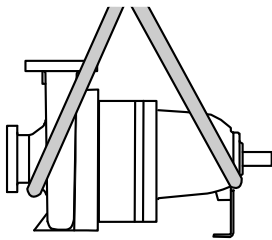

Fig. 2: Transporting the pump

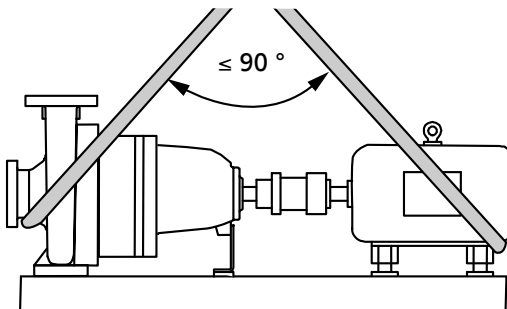

Fig. 3: Transporting the pump set

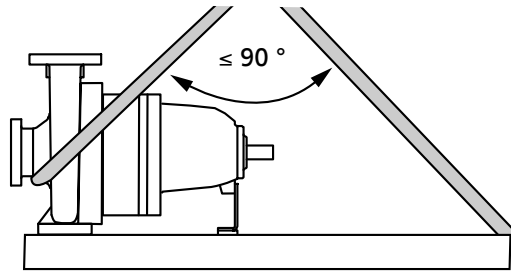



Fig. 4: Transporting the pump on the baseplate

### 3.3 Storage/preservation

If commissioning is to take place some time after delivery, we recommend that the following measures be taken for pump (set) storage.

	<p><b>CAUTION</b></p>
	<p><b>Damage during storage due to humidity, dirt or vermin</b> Corrosion/contamination of the pump (set)!</p> <ul style="list-style-type: none"> <li>▷ For outdoor storage cover the pump (set) or the packaged pump (set) and accessories with waterproof material.</li> </ul>
	<p><b>CAUTION</b></p>
	<p><b>Wet, contaminated or damaged openings and connections</b> Leakage or damage to the pump!</p> <ul style="list-style-type: none"> <li>▷ Clean and cover pump openings and connections as required prior to putting the pump into storage.</li> </ul>

Store the pump (set) in a dry, protected room where the atmospheric humidity is as constant as possible.

Rotate the shaft by hand once a month, e.g. via the motor fan.

If properly stored indoors, the pump set is protected for a maximum of 12 months. New pumps/pump sets are supplied by our factory duly prepared for storage.



For storing a pump (set) which has already been operated, the shutdown measures must be adhered to. (⇒ Section 6.3.1, Page 39)

### 3.4 Return to supplier

1. Drain the pump as per operating instructions. (⇒ Section 7.3, Page 46)
2. Flush and clean the pump, particularly if it has been used for handling noxious, explosive, hot or other hazardous fluids.
3. If the pump has handled fluids whose residues could lead to corrosion damage in the presence of atmospheric humidity or could ignite upon contact with oxygen also neutralise the pump and blow through with anhydrous inert gas to ensure drying.
4. Always complete and enclose a certificate of decontamination when returning the pump.  
Indicate any safety measures and decontamination measures taken.  
(⇒ Section 11, Page 64)

	<p><b>NOTE</b></p>
	<p>If required, a blank certificate of decontamination can be downloaded from the following web site: <a href="http://www.ksb.com/certificate_of_decontamination">www.ksb.com/certificate_of_decontamination</a></p>

### 3.5 Disposal

	 <b>WARNING</b>
	<p><b>Fluids handled, consumables and supplies which are hot and/or pose a health hazard</b></p> <p>Hazard to persons and the environment!</p> <ul style="list-style-type: none"><li>▷ Collect and properly dispose of flushing fluid and any fluid residues.</li><li>▷ Wear safety clothing and a protective mask if required.</li><li>▷ Observe all legal regulations on the disposal of fluids posing a health hazard.</li></ul>

1. Dismantle the pump (set).  
Collect greases and other lubricants during dismantling.
2. Separate and sort the pump materials, e.g. by:
  - Metals
  - Plastics
  - Electronic waste
  - Greases and other lubricants
3. Dispose of materials in accordance with local regulations or in another controlled manner.

## 4 Description of the Pump (Set)

### 4.1 General description

- Process pump with shaft seal

Pump for handling aggressive, inorganic and organic liquids in the chemical and petrochemical industries.

### 4.2 Designation

**Example: CPKN - C1 F 400-506**

**Table 5: Key to the designation**

Code	Description
CPKN	Type series
C1	Casing material e.g. C1 = stainless steel
F	Additional code, e.g. F = off-standard flange design
400	Nominal discharge nozzle diameter [mm]
506	Nominal impeller diameter [mm]

### 4.3 Name plate

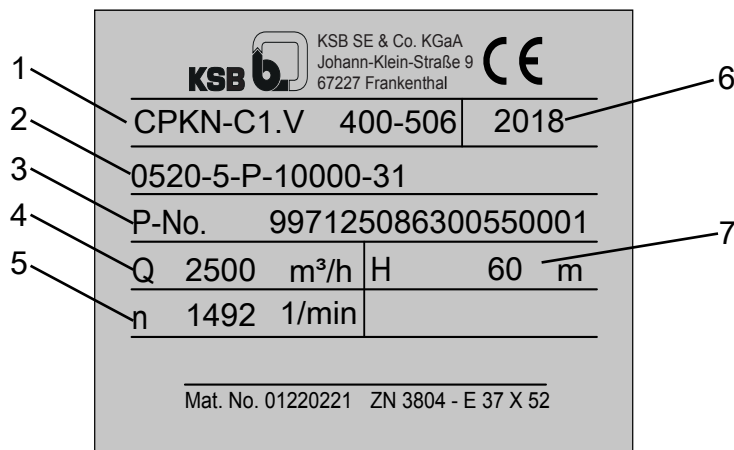

**Fig. 5: Name plate (example)**

1	Type series, size	2	Customer-specific information (optional)
3	KSB order and order item number	4	Flow rate
5	Speed	6	Year of construction
7	Head		

### 4.4 Design details

#### Design

- Volute casing pump
- Horizontal installation
- Back pull-out design
- Single-stage
- Meets the technical requirements to ISO 5199
- Dimensions and ratings to EN 22 858/ISO 2858  
Nominal diameters DN 150 to DN 400



**Pump casing**

- Double volute
- Radially split volute casing
- Volute casing with integrally cast pump feet
- Volute casing with casing wear ring and casing cover

**Impeller type**

- Closed radial impeller with multiply curved vanes
- Sealing clearance on both sides and balancing holes balance axial thrust

**Shaft seal**

- Gland packing
- Commercial single mechanical seals and double mechanical seals

**Preferable:**

- Standardised mechanical seals to EN 12756, K design

**Possible:**

- Commercial cartridge seals

**Table 6: Seal chamber with different shaft seals (examples)**

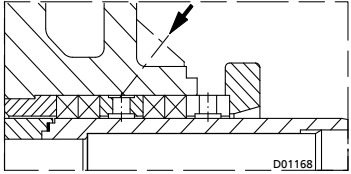
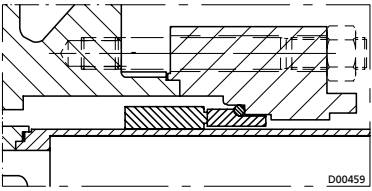
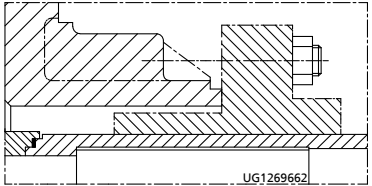
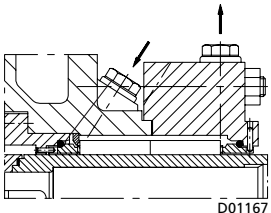
Type of seal	Drawing
Gland packing	
Cylindrical seal chamber Standardised mechanical seal	
Cartridge seal with cylindrical casing cover	
Double mechanical seal (back-to-back), both sides unbalanced	

**Bearings**

**Drive-end bearing:**

- Fixed bearing
- Paired angular contact ball bearings
- Axial movement of the rotor limited to 0.5 mm maximum
- Oil lubrication

**Pump-end bearing:**

- Radial bearing
- Cylindrical roller bearing
- Absorbs radial loads only
- Oil lubrication

**Bearing bracket designation Example: P10as**

**Table 7:** Bearing bracket designation

Code	Description
P	Bearing bracket
10	Size code (based on dimensions of seal chamber and shaft end)
a	Reinforced bearing bracket (next bearing size up)
s	Paired angular contact ball bearings (drive end)

**Bearings used Table 8:** Bearing design

KSB designation	FAG designation	SKF designation
B.G	B-TVP-UA	BECBP

**Table 9:** Bearing design

Bearing bracket	Cylindrical roller bearing (DIN 5412)	Angular contact ball bearing (DIN 628)
P08s	NU 416	7319 B. G
P10as	NU 324	7324 B. G
P12s	NU 324	7324 B. G

**4.5 Design and function**

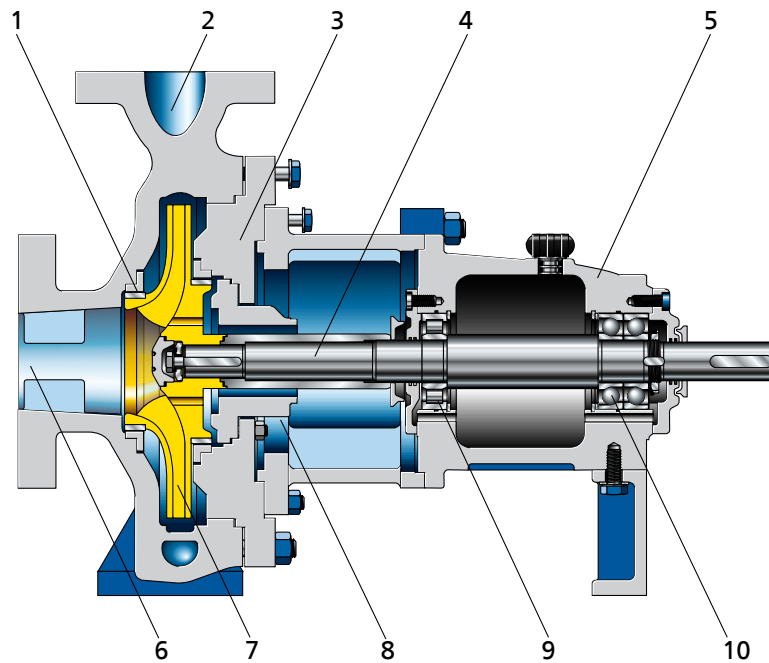

**Fig. 6:** Sectional drawing

1	Clearance gap	2	Discharge nozzle
3	Casing cover	4	Drive shaft
5	Bearing bracket	6	Suction nozzle
7	Impeller	8	Shaft seal
9	Rolling element bearing, pump end	10	Rolling element bearing, drive end

## 4 Description of the Pump (Set)

- Design** The pump is designed with an axial fluid inlet and a radial or tangential outlet. The hydraulic system runs in its own bearings and is connected to the motor by a shaft coupling.
- Function** The fluid enters the pump axially via the suction nozzle (6) and is accelerated outward by the rotating impeller (7). In the flow passage of the pump casing the kinetic energy of the fluid is converted into pressure energy. The fluid is pumped to the discharge nozzle (2), where it leaves the pump. The clearance gap (1) prevents any fluid from flowing back from the casing to the suction nozzle. At the rear side of the impeller, the shaft (4) enters the casing via the casing cover (3). The shaft passage through the cover is sealed to atmosphere with a shaft seal (8). The shaft runs in rolling element bearings (9 and 10), which are supported by a bearing bracket (5) linked with the pump casing and/or casing cover.
- Sealing** The pump is sealed by a shaft seal (standardised mechanical seal or gland packing).

### 4.6 Noise characteristics

**Table 10:** Surface sound pressure level  $L_{pA}$ <sup>3)4)</sup>

$P_N$	Pump			Pump set		
	960 rpm, 760 rpm	1450 rpm	2900 rpm	960 rpm, 760 rpm	1450 rpm	2900 rpm
[kW]	[dB]	[dB]	[dB]	[dB]	[dB]	[dB]
1,5	52	53	54	56	58	63
2,2	53	55	56	58	60	66
3	55	56	57	60	62	68
4	56	58	59	61	63	69
5,5	58	59	61	62	65	71
7,5	59	61	62	64	66	72
11	61	63	64	65	68	74
15	63	65	66	67	69	75
18,5	64	66	67	68	70	76
22	65	67	68	68	71	77
30	66	68	70	70	72	78
37	67	70	71	70	73	79
45	68	71	72	71	74	80
55	69	72	73	72	74	80
75	71	73	75	73	76	81
90	71	74	76	73	76	82
110	72	75	77	74	77	82
132	73	76	78	75	77	83
160	74	77	79	75	78	84
200	75	78	80	76	79	84
250	-	79	81	-	80	85

### 4.7 Scope of supply

Depending on the model, the following items are included in the scope of supply:

- Pump

#### Drive

- Surface-cooled IEC frame three-phase squirrel-cage motor

3) Surface sound pressure level as per ISO 3744 and EN 12639; valid for pump operation in the  $Q/Q_{opt} = 0.8 - 1.1$  range and for non-cavitating operation. If noise levels are to be guaranteed: add +3 dB for measuring and constructional tolerance.  
4) Increase for 60 Hz operation: 3500 rpm +3 dB, 1750 rpm +1 dB, 1160 rpm  $\pm 0$  dB

### **Coupling**

- Flexible coupling with or without spacer

### **Contact guard**

- Coupling guard

### **Baseplate**

- Cast or welded baseplate for the complete unit (pump and motor), in torsion-resistant design

### **Special accessories**



- As required

## **4.8 Dimensions and weights**

For dimensions and weights please refer to the general arrangement drawing/outline drawing of the pump/pump set.



## 5 Installation at Site

### 5.1 Safety regulations

	 <b>DANGER</b>
	<p><b>Excessive temperatures in the shaft seal area</b> Explosion hazard!</p> <ul style="list-style-type: none"> <li>▷ Never operate a pump (set) with gland packing in potentially explosive atmospheres.</li> </ul>

### 5.2 Checks to be carried out prior to installation





#### Place of installation

	 <b>WARNING</b>
	<p><b>Installation on mounting surface which is unsecured and cannot support the load</b> Personal injury and damage to property!</p> <ul style="list-style-type: none"> <li>▷ Use a concrete of compressive strength class C12/15 which meets the requirements of exposure class XC1 to EN 206-1.</li> <li>▷ The mounting surface must be set, flat, and level.</li> <li>▷ Observe the weights indicated.</li> </ul>

1. Check the structural requirements.  
All structural work required must have been prepared in accordance with the dimensions stated in the outline drawing/general arrangement drawing.

### 5.3 Installing the pump set

Always install the pump set in horizontal position.

	 <b>DANGER</b>
	<p><b>Excessive temperatures due to improper installation</b> Explosion hazard!</p> <ul style="list-style-type: none"> <li>▷ Install the pump in a horizontal position to ensure self-venting of the pump.</li> </ul>
	 <b>DANGER</b>
	<p><b>Static charging due to insufficient potential equalisation</b> Explosion hazard!</p> <ul style="list-style-type: none"> <li>▷ Make sure that the connection between pump and baseplate is electrically conductive.</li> </ul>

5.3.1 Installation on the foundation

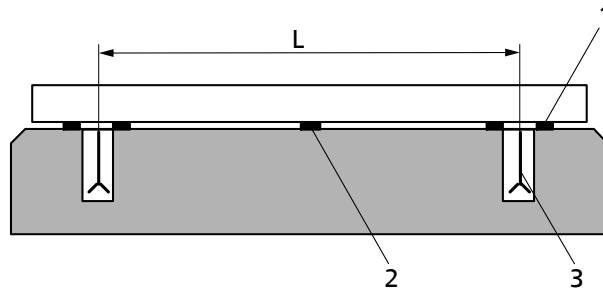

Fig. 7: Fitting the shims



L	Bolt-to-bolt distance	1	Shim
2	Shim if (L) > 800 mm	3	Foundation bolt

- ✓ The foundation has the required strength and characteristics.
  - ✓ The foundation has been prepared in accordance with the dimensions given in the outline drawing/general arrangement drawing.
1. Position the pump set on the foundation and level it with the help of a spirit level placed on the shaft and discharge nozzle.  
Permissible deviation: 0.2 mm/m
  2. Use shims (1) for height compensation if necessary.  
Always fit shims, if any, immediately to the left and right of the foundation bolts (3) between the baseplate/foundation frame and the foundation.  
For a bolt-to-bolt distance (L) > 800 mm fit additional shims (2) halfway between the bolt holes.  
All shims must lie perfectly flush.
  3. Insert the foundation bolts (3) into the holes provided.
  4. Use concrete to set the foundation bolts (3) into the foundation.
  5. Wait until the concrete has set firmly, then level the baseplate.
  6. Tighten the foundation bolts (3) evenly and firmly.
  7. Grout the baseplate using low-shrinkage concrete with a standard particle size and a water/cement ratio of  $\leq 0.5$ .  
Produce flowability with the help of a solvent.  
Perform secondary treatment of the concrete to EN 206.

	<b>NOTE</b>
	For low-noise operation contact the manufacturer to check whether the pump set can be installed on anti-vibration mounts.
	<b>NOTE</b>
	Expansion joints can be fitted between the pump and the suction/discharge line.

## 5.4 Piping

## 5.4.1 Connecting the piping

	<p><b>⚠ DANGER</b></p> <p><b>Impermissible loads acting on the pump nozzles</b>          Danger to life from escaping hot, toxic, corrosive or flammable fluids!</p> <ul style="list-style-type: none"> <li>▷ Do not use the pump as an anchorage point for the piping.</li> <li>▷ Anchor the pipes in close proximity to the pump and connect them properly without transmitting any stresses or strains.</li> <li>▷ Observe the permissible forces and moments at the pump nozzles. (⇒ Section 5.4.2, Page 24)</li> <li>▷ Take appropriate measures to compensate for thermal expansion of the piping.</li> </ul>
	<p><b>CAUTION</b></p> <p><b>Incorrect earthing during welding work at the piping</b>          Destruction of rolling element bearings (pitting effect)!</p> <ul style="list-style-type: none"> <li>▷ Never earth the electric welding equipment on the pump or baseplate.</li> <li>▷ Prevent current flowing through the rolling element bearings.</li> </ul>
	<p><b>NOTE</b></p> <p>Installing check and shut-off elements in the system is recommended, depending on the type of plant and pump. However, such elements must not obstruct proper drainage or hinder disassembly of the pump.</p>

- ✓ Suction lift lines have been laid with a rising slope, suction head lines with a downward slope towards the pump.
- ✓ A flow stabilisation section having a length equivalent to at least twice the diameter of the suction flange has been provided upstream of the suction flange.
- ✓ The nominal diameters of the pipelines are at least equal to the nominal diameters of the pump nozzles.
- ✓ Adapters to larger diameters have a diffuser angle of approximately 8° to prevent excessive pressure losses.
- ✓ The pipelines have been anchored in close proximity to the pump and connected without transmitting any stresses or strains.

	<p><b>CAUTION</b></p> <p><b>Welding beads, scale and other impurities in the piping</b>          Damage to the pump!</p> <ul style="list-style-type: none"> <li>▷ Remove any impurities from the piping.</li> <li>▷ If necessary, install a filter.</li> <li>▷ Observe the information in (⇒ Section 7.2.2.3, Page 45) .</li> </ul>
---	---

1. Thoroughly clean, flush and blow through all vessels, pipelines and connections (especially of new installations).
2. Before installing the pump in the piping, remove the flange covers on the suction and discharge nozzles of the pump.
3. Check that the inside of the pump is free from any foreign objects. Remove any foreign objects.

4. If required, install a filter in the piping (see figure: Filter in the piping).

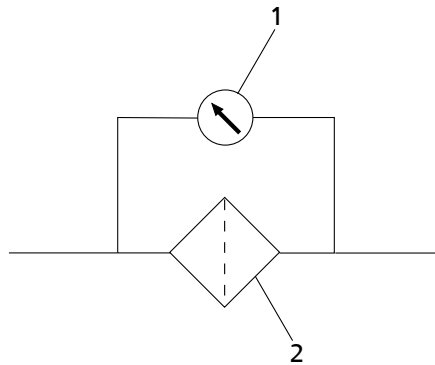

Fig. 8: Filter in the piping

1	Differential pressure gauge	2	Filter
---	-----------------------------	---	--------

	<b>NOTE</b>
	<p>Use a filter with laid-in wire mesh (mesh width 0.5 mm, wire diameter 0.25 mm) of corrosion-resistant material. Use a filter with a filter area three times the cross-section of the piping. Conical filters have proved suitable.</p>

5. Connect the pump nozzles to the piping.

	<b>CAUTION</b>
	<p><b>Aggressive flushing liquid and pickling agent</b> Damage to the pump! ▶ Match the cleaning operation mode and duration of flushing and pickling to the casing materials and seal materials used.</p>

5.4.2 Permissible forces and moments at the pump nozzles

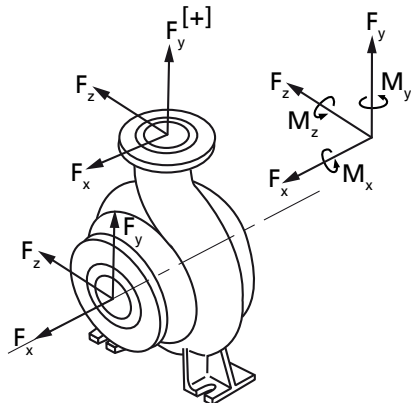

The resulting permissible forces have been determined according to the following formulas:

$$F_{res D} \leq \sqrt{F_x^2 + F_z^2}$$

$$F_{res S} \leq \sqrt{F_y^2 + F_z^2}$$

Forces and moments at the pump nozzles

The data on forces and moments apply to static piping loads only. If the limits are exceeded, they must be checked and verified.

If a computerised strength analysis is required, values are available on request only.

The values are only applicable if the pump is installed on a completely grouted baseplate and bolted to a rigid and level foundation.



**Table 11:** Forces and moments at the pump nozzles

Sizes	Suction nozzle [N]				Discharge nozzle [N]					Suction nozzle [Nm]			Discharge nozzle [Nm]		
	F <sub>x</sub>	F <sub>y</sub>	F <sub>z</sub>	F <sub>res</sub>	F <sub>x</sub>	F <sub>yTens</sub> +	F <sub>yCompr</sub> -	F <sub>z</sub>	F <sub>res</sub>	M <sub>x</sub>	M <sub>y</sub>	M <sub>z</sub>	M <sub>x</sub>	M <sub>y</sub>	M <sub>z</sub>
150-630	7350	4700	5700	7400	3750	2350	4700	3100	4850	5300	3850	2650	3450	2650	1750
200-670	10000	6700	8000	10450	5700	3550	7350	4700	7400	7500	5700	3650	5300	3850	2650
250-630	12000	8000	10000	12800	8000	5000	10000	6700	10450	9150	6900	4500	7500	5700	3650
250-710	12000	8000	10000	12800	8000	5000	10000	6700	10450	9150	6900	4500	7500	5700	3650
300-630	13350	8700	10700	13800	10000	6150	12000	8000	12800	9550	7150	4700	9150	6900	4500
300-710	13350	8700	10700	13800	10000	6150	12000	8000	12800	9550	7150	4700	9150	6900	4500
350-630	15350	10000	12700	16200	10700	6700	13350	8700	13800	11000	8150	5500	9550	7150	4700
350-710	15350	10000	12700	16200	10700	6700	13350	8700	13800	11000	8150	5500	9550	7150	4700
400-504	15350	10000	12700	16200	12700	8000	15350	10000	16200	11000	8150	5500	11000	8150	5500
400-506	15350	10000	12700	16200	12700	8000	15350	10000	16200	11000	8150	5500	11000	8150	5500
400-630	15350	10000	12700	16200	12700	8000	15350	10000	16200	11000	8150	5500	11000	8150	5500
400-710	15350	10000	12700	16200	12700	8000	15350	10000	16200	11000	8150	5500	11000	8150	5500

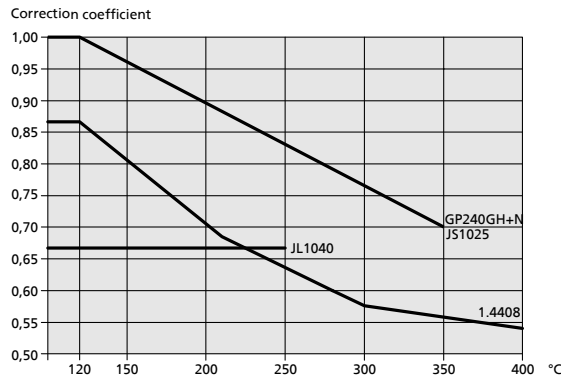

Correction coefficients depending on material and temperature (see diagram below).





**Fig. 9:** Temperature correction diagram



**5.4.3 Auxiliary connections**

	<p><b>⚠ DANGER</b></p>
	<p>Risk of potentially explosive atmosphere by mixing of incompatible fluids in the auxiliary piping                  Risk of burns!                  Explosion hazard!</p> <p>▷ Make sure that the barrier fluid or quench liquid are compatible with the fluid handled.</p>

	 <b>WARNING</b>
	<p><b>Failure to use or incorrect use of auxiliary connections (e.g. barrier fluid, flushing liquid, etc.)</b>                  Risk of injury from escaping fluid!                  Risk of burns!                  Malfunction of the pump!</p> <ul style="list-style-type: none"> <li>▸ Refer to the general arrangement drawing, the piping layout and pump markings (if any) for the quantity, dimensions and locations of auxiliary connections.</li> <li>▸ Use the auxiliary connections provided.</li> </ul>



**5.5 Enclosure/insulation**

	 <b>DANGER</b>
	<p><b>Risk of potentially explosive atmosphere due to insufficient venting</b>                  Explosion hazard!</p> <ul style="list-style-type: none"> <li>▸ Make sure the space between the casing cover/discharge cover and the bearing cover is sufficiently vented.</li> <li>▸ Never close or cover the perforation of the bearing bracket guards (e.g. by insulation).</li> </ul>

	 <b>WARNING</b>
	<p><b>The volute casing and casing/discharge cover take on the same temperature as the fluid handled</b>                  Risk of burns!</p> <ul style="list-style-type: none"> <li>▸ Insulate the volute casing.</li> <li>▸ Fit protective equipment.</li> </ul>

	<b>CAUTION</b>
	<p><b>Heat build-up in the bearing bracket</b>                  Damage to the bearing!</p> <ul style="list-style-type: none"> <li>▸ Never insulate the bearing bracket, bearing bracket lantern and casing cover.</li> </ul>

**5.6 Checking the coupling alignment**

 	 <b>DANGER</b>
	<p><b>Inadmissible temperatures at the coupling or bearings due to misalignment of the coupling</b>                  Explosion hazard!                  Risk of burns!</p> <ul style="list-style-type: none"> <li>▸ Make sure that the coupling is correctly aligned at all times.</li> </ul>

	CAUTION
<p><b>Misalignment of pump and motor shafts</b> Damage to pump, motor and coupling!</p> <ul style="list-style-type: none"> <li>▷ Always check the coupling after the pump has been installed and connected to the piping.</li> <li>▷ Also check the coupling of pump sets supplied with pump and motor mounted on the same baseplate.</li> </ul>	

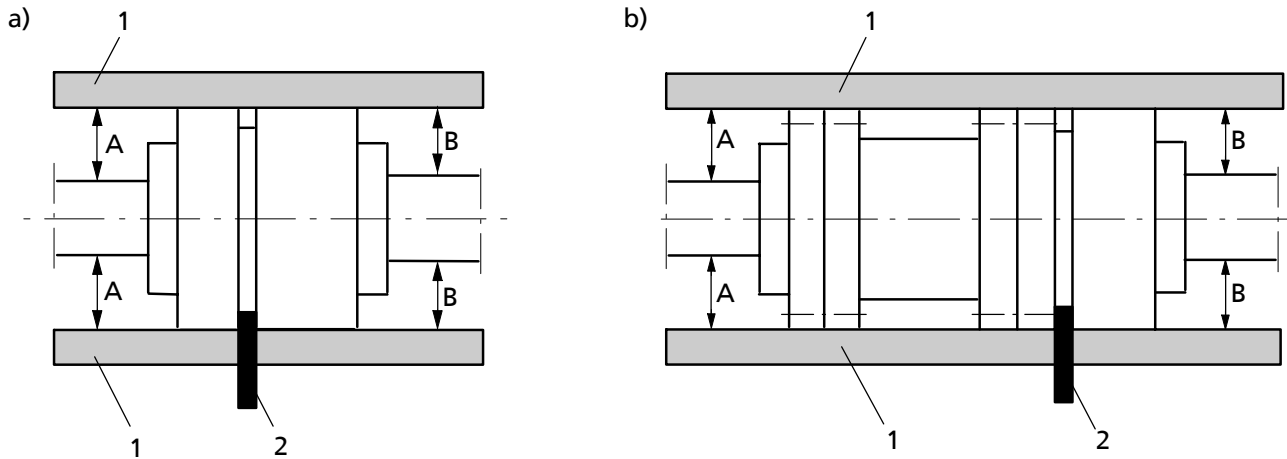

**Fig. 10:** Checking the coupling alignment: Coupling without spacer sleeve (a) or Coupling with spacer sleeve (b)

1	Straight-edge	2	Gauge
---	---------------	---	-------

- ✓ The coupling guard and its footboard, if any, have been removed.
  1. Loosen the support foot and re-tighten it without transmitting any stresses and strains.
  2. Place the straight-edge axially on both coupling halves.
  3. Leave the straight-edge in this position and turn the coupling by hand.  
The coupling is aligned correctly if the distances A and B to the respective shafts are the same at all points around the circumference.  
The radial and axial deviation between the two coupling halves must not exceed 0.1 mm, during standstill as well as at operating temperature and under inlet pressure.
  4. Check the distance (dimension see general arrangement drawing) between the two coupling halves around the circumference.  
The coupling is correctly aligned if the distance between the two coupling halves is the same at all points around the circumference.  
The radial and axial deviation between the two coupling halves must not exceed 0.1 mm, during standstill as well as at operating temperature and under inlet pressure.
  5. If alignment is correct, re-install the coupling guard and its footboard, if any.

#### Checking the coupling alignment with a laser tool

Coupling alignment may also be checked with a laser tool. Observe the documentation provided by the manufacturer of the measuring instrument.

#### 5.7 Aligning the pump and motor

After having installed the pump set and connected the piping, check the coupling alignment and, if required, re-align the pump set (with the motor).

Any differences in shaft centre height between the pump and the motor are compensated by means of shims.

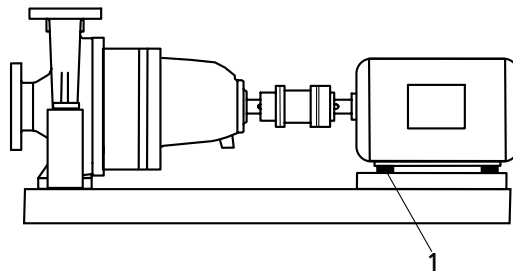



Fig. 11: Pump set with shim



1	Shim
---	------

✓ The coupling guard and its footboard, if any, have been removed.



1. Check the coupling alignment.
2. Loosen the hexagon head bolts at the motor.
3. Insert shims underneath the motor feet until the difference in shaft centreline height has been compensated.
4. Re-tighten the hexagon head bolts.
5. Check proper functioning of coupling/shaft.  
Check that coupling/shaft can easily be rotated by hand.

	 <b>WARNING</b>
	<p><b>Unprotected rotating coupling</b> Risk of injury by rotating shafts!</p> <ul style="list-style-type: none"> <li>▷ Always operate the pump set with a coupling guard. If the customer specifically requests not to include a coupling guard in KSB's delivery, then the operator must supply one!</li> <li>▷ Observe all relevant regulations for selecting a coupling guard.</li> </ul>

6. Fit the coupling guard and its footboard, if any.
7. Check the distance between coupling and coupling guard.  
The coupling guard must not touch the coupling.

	 <b>DANGER</b>
	<p><b>Risk of ignition by frictional sparks</b> Explosion hazard!!</p> <ul style="list-style-type: none"> <li>▷ Choose a coupling guard material that is non-sparking in the event of mechanical contact.</li> </ul>

### 5.8 Electrical connection

	 <b>DANGER</b>
	<p><b>Electrical connection work by unqualified personnel</b> Risk of fatal injury due to electric shock!</p> <ul style="list-style-type: none"> <li>▷ Always have the electrical connections installed by a trained and qualified electrician.</li> <li>▷ Observe regulations IEC 60364 and, for explosion-proof models, EN 60079.</li> </ul>

	<b>⚠ WARNING</b>
	<p><b>Incorrect connection to the mains</b>                  Damage to the mains network, short circuit!</p> <ul style="list-style-type: none"> <li>▸ Observe the technical specifications of the local energy supply companies.</li> </ul>

1. Check the available mains voltage against the data on the motor name plate.
2. Select an appropriate starting method.

	<b>NOTE</b>
	<p>A motor protection device is recommended.</p>



**5.8.1 Setting the time relay**

	<b>CAUTION</b>
	<p><b>Switchover between star and delta on three-phase motors with star-delta starting takes too long.</b>                  Damage to the pump (set)!</p> <ul style="list-style-type: none"> <li>▸ Keep switch-over intervals between star and delta as short as possible.</li> </ul>

**Table 12:** Time relay settings for star-delta starting:

Motor rating [kW]	Y time to be set [s]
≤ 30	< 3
> 30	< 5

**5.8.2 Earthing**





 	<b>⚠ DANGER</b>
	<p><b>Electrostatic charging</b>                  Explosion hazard!                  Damage to the pump set!</p> <ul style="list-style-type: none"> <li>▸ Connect the PE conductor to the earthing terminal provided.</li> <li>▸ Provide for potential equalisation between the pump set and foundation.</li> </ul>

**5.8.3 Connecting the motor**

	<b>NOTE</b>
	<p>In compliance with IEC 60034-8, three-phase motors are always wired for clockwise rotation (looking at the motor shaft stub).                  The pump's direction of rotation is indicated by an arrow on the pump.</p>

1. Match the motor's direction of rotation to that of the pump.
2. Observe the manufacturer's product literature supplied with the motor.

## 5.9 Checking the direction of rotation

	<p><b>⚠ DANGER</b></p> <p><b>Temperature increase resulting from contact between rotating and stationary components</b> Explosion hazard! Damage to the pump set!</p> <ul style="list-style-type: none"> <li>▷ Never check the direction of rotation by starting up the unfilled pump set.</li> <li>▷ Separate the pump from the motor to check the direction of rotation.</li> </ul>
	<p><b>⚠ WARNING</b></p> <p><b>Hands inside the pump casing</b> Risk of injuries, damage to the pump!</p> <ul style="list-style-type: none"> <li>▷ Always disconnect the pump set from the power supply and secure it against unintentional start-up before inserting your hands or other objects into the pump.</li> </ul>
	<p><b>CAUTION</b></p> <p><b>Incorrect direction of rotation with non-reversible mechanical seal</b> Damage to the mechanical seal and leakage!</p> <ul style="list-style-type: none"> <li>▷ Separate the pump from the motor to check the direction of rotation.</li> </ul>
	<p><b>CAUTION</b></p> <p><b>Drive and pump running in the wrong direction of rotation</b> Damage to the pump!</p> <ul style="list-style-type: none"> <li>▷ Refer to the arrow indicating the direction of rotation on the pump.</li> <li>▷ Check the direction of rotation. If required, check the electrical connection and correct the direction of rotation.</li> </ul>

The correct direction of rotation of the motor and pump is clockwise (seen from the drive end).

1. Start the motor and stop it again immediately to determine the motor's direction of rotation.
2. Check the direction of rotation.  
The motor's direction of rotation must match the arrow indicating the direction of rotation on the pump.
3. If the motor is running in the wrong direction of rotation, check the electrical connection of the motor and switchgear, if any.

## 6 Commissioning/Start-up/Shutdown

### 6.1 Commissioning/Start-up

#### 6.1.1 Prerequisites for commissioning/start-up

Before commissioning/starting up the pump set, make sure that the following conditions are met:

- The pump set has been mechanically connected as specified.
- The pump set has been properly connected to the power supply and is equipped with all protection devices. (⇒ Section 5.8, Page 28)
- The pump has been primed with the fluid to be handled. The pump has been vented. (⇒ Section 6.1.4, Page 33)
- The direction of rotation has been checked. (⇒ Section 5.9, Page 30)
- All auxiliary connections required are connected and operational.
- The lubricants have been checked.
- After prolonged shutdown of the pump (set), the activities required for returning the equipment to service have been carried out. (⇒ Section 6.4, Page 40)

#### 6.1.2 Filling in lubricants



Fill the bearing bracket with lubricating oil.

Oil quality see (⇒ Section 7.2.3.1.2, Page 45)

Oil quantity see (⇒ Section 7.2.3.1.3, Page 46)

#### Filling the constant level oiler with lubricating oil (oil-lubricated bearings only)

- ✓ The constant level oiler has been fitted.

	<p style="background-color: #0070C0; color: white; padding: 5px;"><b>NOTE</b></p> <p>If no constant level oiler is provided on the bearing bracket, the oil level can be read in the middle of the oil level gauge arranged at the side of the bearing bracket.</p>
	<p style="background-color: #FFD700; padding: 5px;"><b>CAUTION</b></p> <p><b>Insufficient quantity of lubricating oil in the reservoir of the constant level oiler</b> Damage to the bearings!</p> <ul style="list-style-type: none"> <li>▷ Regularly check the oil level.</li> <li>▷ Always fill the oil reservoir completely.</li> <li>▷ Keep the oil reservoir properly filled at all times.</li> </ul>

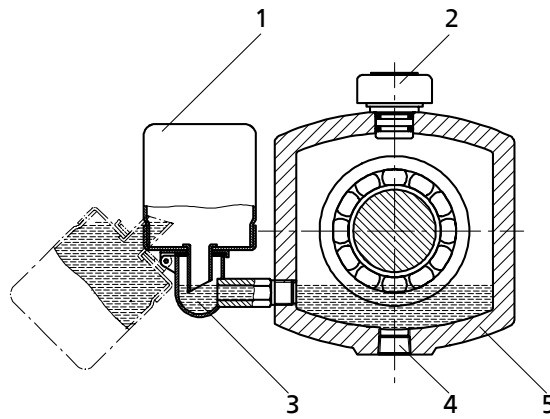

Fig. 12: Bearing bracket with constant level oiler

1	Constant level oiler	2	Vent plug
3	Connection elbow of the constant level oiler	4	Screw plug
5	Bearing bracket		

1. Pull out the vent plug (2).
2. Hinge down the reservoir of the constant level oiler (1) from the bearing bracket (5) and hold it in this position.
3. Fill in oil through the hole for the vent plug until the oil reaches the connection elbow of the constant level oiler (3).
4. Completely fill the reservoir of the constant level oiler (1).
5. Snap the constant level oiler (1) back into its operating position.
6. Fit the vent plug (2) again.
7. After approximately 5 minutes, check the oil level in the glass reservoir of the constant level oiler (1).  
The oil reservoir must be properly filled at all times to ensure that the correct oil level is maintained. Repeat steps 1 - 6, if necessary.
8. To check the function of the constant level oiler (1), slowly drain some oil via the screw plug (4) until air bubbles can be seen in the oil reservoir.



#### NOTE

An excessively high oil level can lead to a temperature rise and to leakage of the fluid handled or oil.

#### 6.1.3 Shaft seal

Shaft seals are fitted prior to delivery.

Observe the instructions on dismantling (⇒ Section 7.4.6, Page 49) or assembly (⇒ Section 7.5.3, Page 52) .

**Reservoir of non-pressurised external fluid**

If applicable, fill the reservoir of non-pressurised external fluid in accordance with the general arrangement drawing.

**Double mechanical seal**



Prior to starting up the pump, apply barrier pressure as specified in the general arrangement drawing.

**External liquid feed**

Apply the quantities and pressures specified in the data sheet and the general arrangement drawing.



## 6.1.4 Priming and venting the pump

	<p><b>⚠ DANGER</b></p> <p><b>Risk of potentially explosive atmosphere by mixing of incompatible fluids in the auxiliary piping</b>  Risk of burns!  Explosion hazard!</p> <ul style="list-style-type: none"> <li>▷ Make sure that the barrier fluid or quench liquid are compatible with the fluid handled.</li> </ul>
	<p><b>⚠ DANGER</b></p> <p><b>Risk of potentially explosive atmosphere inside the pump</b>  Explosion hazard!</p> <ul style="list-style-type: none"> <li>▷ The pump internals in contact with the fluid to be handled, including the seal chamber and auxiliary systems must be filled with the fluid to be handled at all times.</li> <li>▷ Provide sufficient inlet pressure.</li> <li>▷ Provide an appropriate monitoring system.</li> </ul>
	<p><b>⚠ DANGER</b></p> <p><b>Shaft seal failure caused by insufficient lubrication</b>  Hot or toxic fluid could escape!  Damage to the pump!</p> <ul style="list-style-type: none"> <li>▷ Before starting up the pump set, vent the pump and suction line and prime both with the fluid to be handled.</li> </ul>

1. Vent the pump and suction line and prime both with the fluid to be handled.
2. Fully open the shut-off element in the suction line.
3. Fully open all auxiliary connections (barrier fluid, flushing liquid, etc).

## 6.1.5 Final check

1. Remove the coupling guard and its footboard, if any.
2. Check the coupling alignment; re-align the coupling, if required.  
(⇒ Section 5.6, Page 26)
3. Check proper functioning of coupling/shaft.  
Check that coupling/shaft can be easily rotated by hand.
4. Fit the coupling guard and its footboard, if any.
5. Check the distance between coupling and coupling guard.  
The coupling guard must not touch the coupling.



## 6.1.6 Water cooling

	<p><b>CAUTION</b></p> <p><b>Deposit-forming, aggressive cooling water</b>  Damage to the pump!</p> <ul style="list-style-type: none"> <li>▷ Observe the cooling water quality.</li> </ul>
---	---

Observe the following quality data of the cooling water:

- Not deposit-forming
- Not aggressive
- Free from suspended solids
- Hardness on average 5 °dH (~1 mmol/l)
- pH > 8
- Conditioned and neutral with regard to mechanical corrosion
- Inlet temperature  $t_{in}$ =10 to 30 °C  
Outlet temperature  $t_{out}$ = 45 °C max.

**6.1.7 Cooling of the shaft seal ("K" design)**

	<b>CAUTION</b>
	<p><b>Vaporisation pressure of fluid handled higher than atmospheric pressure</b> Damage to the shaft seal/pump!</p> <ul style="list-style-type: none"> <li>▷ Cool the shaft seal.</li> <li>▷ Provide sufficient quantities of cooling liquid (see table).</li> </ul>
	<b>NOTE</b>
	<p>The vaporisation pressure varies depending on the fluid handled, the system pressure and the material of the shaft seal (e.g. hot water).</p>

Observe the following data for the cooling liquid:

- Max. permissible cooling liquid pressure: 10 bar
- Cooling liquid quantities: (see table below)

**Table 13:** Cooling liquid quantity depending on the bearing bracket

Bearing bracket	Temperature of the fluid handled	
	up to 250 °C	up to 400 °C
P08s	8	10
P10as	8	10
P12s	8	10

**6.1.8 Bearing bracket cooling**

When installing the cooled bearing bracket, make sure the following values are met:

- Cooling liquid quantity: approx. 3.3 l/min
- Cooling liquid pressure: 10 bar

**6.1.9 Heating up/keeping warm the pump (set)**

	<b>CAUTION</b>
	<p><b>Pump blockage</b> Damage to the pump!</p> <ul style="list-style-type: none"> <li>▷ Prior to pump start-up, heat up the pump as described in the manual.</li> </ul>





Observe the following when heating up the pump (set) and keeping it warm:

- Make sure that the temperature is increased continuously.
- Max. heating speed: 10 °C/min (10 K/min)

**Fluid temperatures above 150 °C** When the pump is used for handling fluids at temperatures above 150 °C make sure that the pump has been heated throughout before starting it up.

**Temperature difference** The temperature difference between the pump's surface and the fluid handled must not exceed 100 °C (100 K) when the pump is started up.

#### 6.1.10 Start-up

	<p><b>⚠ DANGER</b></p> <p><b>Non-compliance with the permissible pressure and temperature limits if the pump is operated with the suction and/or discharge line closed.</b></p> <p>Explosion hazard! Hot or toxic fluids escaping!</p> <ul style="list-style-type: none"> <li>▷ Never operate the pump with the shut-off elements in the suction line and/or discharge line closed.</li> <li>▷ Only start up the pump set with the discharge-side shut-off element slightly or fully open.</li> </ul>
	<p><b>⚠ DANGER</b></p> <p><b>Excessive temperatures due to dry running or excessive gas content in the fluid handled</b></p> <p>Explosion hazard! Damage to the pump set!</p> <ul style="list-style-type: none"> <li>▷ Never operate the pump set without liquid fill.</li> <li>▷ Prime the pump as per operating instructions. (⇒ Section 6.1.4, Page 33)</li> <li>▷ Always operate the pump within the permissible operating range.</li> </ul>
	<p><b>CAUTION</b></p> <p><b>Abnormal noises, vibrations, temperatures or leakage</b></p> <p>Damage to the pump!</p> <ul style="list-style-type: none"> <li>▷ Switch off the pump (set) immediately.</li> <li>▷ Eliminate the causes before returning the pump set to service.</li> </ul>
	<p><b>CAUTION</b></p> <p><b>Start-up against open discharge line</b></p> <p>Motor overload!</p> <ul style="list-style-type: none"> <li>▷ Make sure the motor has sufficient power reserves.</li> <li>▷ Use a soft starter.</li> <li>▷ Use speed control.</li> </ul>

- ✓ The system piping has been cleaned.
- ✓ The pump, suction line and, if applicable, inlet tank have been vented and primed with the fluid to be handled.
- ✓ The lines for priming and venting have been closed.

1. Fully open the shut-off element in the suction head/suction lift line.
2. Close or slightly open the shut-off element in the discharge line.
3. Start up the motor.

- Immediately after the pump has reached full rotational speed, slowly open the shut-off element in the discharge line and adjust it to comply with the duty point.

	<b>CAUTION</b>
	<p><b>Misalignment of pump and coupling</b> Damage to pump, motor and coupling!</p> <ul style="list-style-type: none"> <li>▷ When the operating temperature has been reached, switch off the pump set and check the coupling alignment.</li> </ul>

- Check the coupling alignment and re-align the coupling, if required.

#### 6.1.11 Checking the shaft seal

**Mechanical seal** The mechanical seal only leaks slightly or invisibly (as vapour) during operation. Mechanical seals are maintenance-free.

**Gland packing** The gland packing must drip slightly during operation.

**Pure graphite packing** If a pure graphite packing is used, there must always be some leakage.

**Table 14:** Leakage rate of the pure graphite packing

Quantity	Values
Minimum	10 cm <sup>3</sup> /min
Maximum	20 cm <sup>3</sup> /min

#### Adjusting the leakage

- Prior to commissioning**
- Only lightly tighten the nuts of the gland follower by hand.
  - Use a feeler gauge to verify that the gland follower is mounted centred and at a right angle to the shaft.
- ⇒ The gland must leak after the pump has been primed.

**After five minutes of operation**

	<b>! WARNING</b>
	<p><b>Unprotected rotating parts</b> Risk of personal injury!</p> <ul style="list-style-type: none"> <li>▷ Do not touch rotating parts.</li> <li>▷ When the pump is running, perform any work with utmost caution.</li> </ul>

The leakage can be reduced.

- Tighten the nuts on the gland follower by 1/6 turn.
- Monitor the leakage for another five minutes.

#### Excessive leakage:

Repeat steps 1 and 2 until the minimum value has been reached.

#### Not enough leakage:

Slightly loosen the nuts at the gland follower.

#### No leakage:

Immediately switch off pump set!

Loosen the gland follower and repeat commissioning.

#### Checking the leakage

After the leakage has been adjusted, monitor the leakage for about two hours at maximum fluid temperature.

Check that enough leakage occurs at the gland packing at minimum fluid pressure.

## 6.1.12 Shutdown

- ✓ The shut-off element in the suction line is and remains open.
- ✓ On pump sets with double mechanical seal, apply the required pressure specified in the general arrangement drawing to the mechanical seal chamber also during standstill.
- ✓ Also ensure quench liquid supply is ON during pump standstill.
  1. Close the shut-off element in the discharge line.
  2. Switch off the motor and make sure the pump set runs down smoothly to a standstill.

	<b>NOTE</b>
	If the discharge line is equipped with a non-return or check valve, the shut-off element may remain open provided that the system conditions and system regulations are considered and observed.



	<b>NOTE</b>
	If shut-off is not possible, the pump will run in reverse direction. The reverse runaway speed must be lower than the rated speed.

For prolonged shutdown periods:

1. Close the shut-off element in the suction line.
2. Close the auxiliary connections.  
If the fluid to be handled is fed in under vacuum, also supply the shaft seal with barrier fluid during standstill.  
Only turn off the cooling liquid supply after the pump has cooled down.

	<b>CAUTION</b>
	<p><b>Risk of freezing during prolonged pump shutdown periods</b></p> <p>Damage to the pump!</p> <ul style="list-style-type: none"> <li>▷ Drain the pump and the cooling/heating chambers (if any) or otherwise protect them against freezing.</li> </ul>

## 6.2 Operating limits

 	<b>⚠ DANGER</b>
	<p><b>Non-compliance with operating limits for pressure, temperature, fluid handled and speed</b></p> <p>Explosion hazard! Hot or toxic fluid could escape!</p> <ul style="list-style-type: none"> <li>▷ Comply with the operating data indicated in the data sheet.</li> <li>▷ Never use the pump for handling fluids it is not designed for.</li> <li>▷ Avoid prolonged operation against a closed shut-off element.</li> <li>▷ Never operate the pump at temperatures, pressures or rotational speeds exceeding those specified in the data sheet or on the name plate unless the written consent of the manufacturer has been obtained.</li> </ul>

	<b>⚠ DANGER</b>
	<p><b>Formation of a potentially explosive atmosphere inside the pump</b></p> <p>Explosion hazard!</p> <ul style="list-style-type: none"> <li>▷ When draining tanks take suitable measures to prevent dry running of the pump (e.g. fill level monitoring).</li> </ul>

## 6.2.1 Ambient temperature

	<b>CAUTION</b>
	<p><b>Operation outside the permissible ambient temperature</b>          Damage to the pump (set)!</p> <p>▷ Observe the specified limits for permissible ambient temperatures.</p>

Observe the following parameters and values during operation:

**Table 15:** Permissible ambient temperatures

Permissible ambient temperature	Value
Maximum	40 °C
Minimum	See data sheet.

## 6.2.2 Frequency of starts

	<b>! DANGER</b>
	<p><b>Excessive surface temperature of the motor</b>          Explosion hazard!          Damage to the motor!</p> <p>▷ In case of explosion-proof motors, observe the frequency of starts specified in the manufacturer's product literature.</p>

The frequency of starts is usually determined by the maximum temperature increase of the motor. This largely depends on the power reserves of the motor in steady-state operation and on the starting conditions (DOL, star-delta, moments of inertia, etc). If the starts are evenly spaced over the period indicated, the following limits serve as orientation for start-up with the discharge-side gate valve slightly open:

**Table 16:** Frequency of starts

Motor rating [kW]	Maximum frequency of starts [Starts/hour]
≤ 12	15
≤ 100	10
> 100	5

	<b>CAUTION</b>
	<p><b>Re-starting while motor is still running down</b>          Damage to the pump (set)!</p> <p>▷ Do not re-start the pump set before the pump rotor has come to a standstill.</p>

## 6.2.3 Fluid handled

## 6.2.3.1 Flow rate

Unless specified otherwise in the characteristic curves or in the data sheets, the following applies:

- Short-time operation:  $Q_{\min}^{5)} = 0.1 \times Q_{\text{opt}}^{6)}$
- Continuous operation:  $Q_{\min}^{5)} = 0.3 \times Q_{\text{opt}}^{6)}$
- 4-pole operation:  $Q_{\max}^{7)} = 1.25 \times Q_{\text{opt}}^{6)}$

5) Minimum permissible flow rate  
 6) Flow rate at best efficiency point  
 7) Maximum permissible flow rate

The data refer to water and water-like fluids. Longer operating periods with these fluids and at the flow rates indicated will not cause an additional increase in the temperatures on the pump surface. However, if the physical properties of the fluids handled differ from those of water, the calculation formula below must be used to check if an additional heat build-up may lead to a dangerous temperature increase at the pump surface. If necessary, the minimum flow must be increased.

$$T_o = T_f + \Delta \vartheta$$

$$\Delta \vartheta = \frac{g \times H}{c \times \eta} \times (1 - \eta)$$

Table 17: Key

Symbol	Description	Unit
c	Specific heat capacity	J/kg K
g	Gravitational constant	m/s <sup>2</sup>
H	Pump discharge head	m
T <sub>f</sub>	Fluid temperature	°C
T <sub>o</sub>	Temperature at the casing surface	°C
η	Pump efficiency at duty point	-
Δϑ	Temperature difference	K

### 6.2.3.2 Density of the fluid handled

The pump input power changes in proportion to the density of the fluid handled.

	<b>CAUTION</b>
	<p><b>Impermissibly high density of the fluid handled</b> Motor overload!</p> <ul style="list-style-type: none"> <li>▷ Observe the information about fluid density in the data sheet.</li> <li>▷ Make sure the motor has sufficient power reserves.</li> </ul>

### 6.2.3.3 Abrasive fluids

Do not exceed the maximum permissible solids content specified in the data sheet. When the pump handles fluids containing abrasive substances, increased wear of the hydraulic system and shaft seal are to be expected. In this case, reduce the commonly recommended inspection intervals.

## 6.3 Shutdown/storage/preservation

### 6.3.1 Measures to be taken for shutdown

#### The pump (set) remains installed

- ✓ Sufficient fluid is supplied for the operation check run of the pump.
  1. For prolonged shutdown periods, start up the pump (set) regularly between once a month and once every three months for approximately five minutes.
    - ⇒ This will prevent the formation of deposits within the pump and the pump intake area.

**The pump (set) is removed from the pipe and stored**



- ✓ The pump has been properly drained. (⇒ Section 7.3, Page 46)
  - ✓ The safety instructions for dismantling the pump have been observed. (⇒ Section 7.4.1, Page 47)
    1. Spray-coat the inside wall of the pump casing and, in particular, the impeller clearance areas with a preservative.
    2. Spray the preservative through the suction nozzle and discharge nozzle. It is advisable to then close the pump nozzles (e.g. with plastic caps).
    3. Oil or grease all exposed machined parts and surfaces of the pump (with silicone-free oil or grease, food-approved if required) to protect them against corrosion.
- Observe the additional instructions on preservation. (⇒ Section 3.3, Page 14)

If the pump set is to be stored temporarily, only preserve the wetted components made of low-alloy materials. Commercially available preservatives can be used for this purpose. Observe the manufacturer's instructions for application/removal.

**6.4 Returning to service**

For returning the equipment to service observe the sections on commissioning/start-up and the operating limits. (⇒ Section 6.1, Page 31) (⇒ Section 6.2, Page 37)





In addition, carry out all servicing/maintenance operations before returning the pump (set) to service. (⇒ Section 7, Page 41)

	<p style="background-color: #f4a460; padding: 5px;"><b>⚠ WARNING</b></p> <p><b>Failure to re-install or re-activate protective devices</b>                  Risk of injury from moving parts or escaping fluid!</p> <ul style="list-style-type: none"> <li>▸ As soon as the work is completed, re-install and re-activate any safety-relevant devices and protective devices.</li> </ul>
	<p style="background-color: #0070c0; color: white; padding: 5px;"><b>NOTE</b></p> <p>If the pump has been out of service for more than one year, replace all elastomer seals.</p>



## 7 Servicing/Maintenance

### 7.1 Safety regulations

	<p><b>⚠ DANGER</b></p> <p><b>Sparks produced during servicing work</b> Explosion hazard!</p> <ul style="list-style-type: none"> <li>▷ Observe the safety regulations in force at the place of installation!</li> <li>▷ Always perform maintenance work at an explosion-proof pump (set) outside of potentially explosive atmospheres.</li> </ul>
	<p><b>⚠ DANGER</b></p> <p><b>Improper cleaning of coated pump surfaces</b> Explosion hazard by electrostatic discharge!</p> <ul style="list-style-type: none"> <li>▷ When cleaning coated pump surfaces in atmospheres of Explosion group IIC, use suitable anti-static equipment.</li> </ul>
	<p><b>⚠ DANGER</b></p> <p><b>Improperly serviced pump set</b> Explosion hazard! Damage to the pump set!</p> <ul style="list-style-type: none"> <li>▷ Service the pump set regularly.</li> <li>▷ Prepare a maintenance schedule with special emphasis on lubricants, shaft seal and coupling.</li> </ul>
<p>The operator ensures that maintenance, inspection and installation is performed by authorised, qualified specialist personnel who are thoroughly familiar with the manual.</p>	
	<p><b>⚠ WARNING</b></p> <p><b>Unintentional starting of the pump set</b> Risk of injury by moving components and shock currents!</p> <ul style="list-style-type: none"> <li>▷ Ensure that the pump set cannot be started unintentionally.</li> <li>▷ Always make sure the electrical connections are disconnected before carrying out work on the pump set.</li> </ul>
	<p><b>⚠ WARNING</b></p> <p><b>Fluids handled, consumables and supplies which are hot and/or pose a health hazard</b> Risk of injury!</p> <ul style="list-style-type: none"> <li>▷ Observe all relevant laws.</li> <li>▷ When draining the fluid take appropriate measures to protect persons and the environment.</li> <li>▷ Decontaminate pumps which handle fluids posing a health hazard.</li> </ul>

	<p><b>⚠ WARNING</b></p>
	<p><b>Insufficient stability</b>                  Risk of crushing hands and feet!</p> <ul style="list-style-type: none"> <li>▷ During assembly/dismantling, secure the pump (set)/pump parts to prevent tilting or tipping over.</li> </ul>



A regular maintenance schedule will help avoid expensive repairs and contribute to trouble-free, reliable operation of the pump, pump set and pump parts with a minimum of servicing/maintenance expenditure and work.



	<p><b>NOTE</b></p>
	<p>All maintenance work, service work and installation work can be carried out by KSB Service or authorised workshops. For contact details please refer to the enclosed "Addresses" booklet or visit "<a href="http://www.ksb.com/contact">www.ksb.com/contact</a>" on the Internet.</p>



Never use force when dismantling and reassembling the pump set.



## 7.2 Servicing/Maintenance

### 7.2.1 Supervision of operation

 	<p><b>⚠ DANGER</b></p>
	<p><b>Excessive temperatures as a result of bearings running hot or defective bearing seals</b>                  Explosion hazard!                  Fire hazard!                  Damage to the pump set!                  Risk of burns!</p> <ul style="list-style-type: none"> <li>▷ Regularly check the lubricant level.</li> <li>▷ Regularly check the rolling element bearings for running noises.</li> </ul>

 	<p><b>⚠ DANGER</b></p>
	<p><b>Incorrectly serviced shaft seal</b>                  Explosion hazard!                  Hot, toxic fluid escaping!                  Damage to the pump set!                  Risk of burns!                  Fire hazard!</p> <ul style="list-style-type: none"> <li>▷ Regularly service the shaft seal.</li> </ul>

 	<p><b>⚠ DANGER</b></p>
	<p><b>Incorrectly serviced barrier fluid system</b>                  Explosion hazard!                  Fire hazard!                  Damage to the pump set!                  Hot and/or toxic fluids escaping!</p> <ul style="list-style-type: none"> <li>▷ Regularly service the barrier fluid system.</li> <li>▷ Monitor the barrier fluid pressure.</li> </ul>



	<p style="text-align: center;"><b>⚠ DANGER</b></p> <p><b>Risk of potentially explosive atmosphere inside the pump</b> Explosion hazard!</p> <ul style="list-style-type: none"> <li>▷ The pump internals in contact with the fluid to be handled, including the seal chamber and auxiliary systems must be filled with the fluid to be handled at all times.</li> <li>▷ Provide sufficient inlet pressure.</li> <li>▷ Provide an appropriate monitoring system.</li> </ul>
	<p style="text-align: center;"><b>CAUTION</b></p> <p><b>Increased wear due to dry running</b> Damage to the pump set!</p> <ul style="list-style-type: none"> <li>▷ Never operate the pump set without liquid fill.</li> <li>▷ Never close the shut-off element in the suction line and/or supply line during pump operation.</li> </ul>
	<p style="text-align: center;"><b>CAUTION</b></p> <p><b>Impermissibly high temperature of fluid handled</b> Damage to the pump!</p> <ul style="list-style-type: none"> <li>▷ Prolonged operation against a closed shut-off element is not permitted (heating up of the fluid).</li> <li>▷ Observe the temperature limits in the data sheet and in the section on operating limits. (⇒ Section 6.2, Page 37)</li> </ul>

While the pump is in operation, observe and check the following:

- The pump must run quietly and free from vibrations at all times.
- In case of oil lubrication, ensure the oil level is correct.
- Check the shaft seal. (⇒ Section 6.1.11, Page 36)
- Check the static sealing elements for leakage.
- Check the rolling element bearings for running noises.  
Vibrations, noise and an increase in current input occurring during unchanged operating conditions indicate wear.
- Monitor the correct functioning of any auxiliary connections.
- Cooling system  
Take the pump out of service at least once a year to thoroughly clean the cooling system.
- Monitor the stand-by pump.  
To make sure that stand-by pumps are ready for operation, start them up once a week.
- Monitor the bearing temperature.  
The bearing temperature must not exceed 90 °C (measured on the outside of the bearing bracket).

	<p style="text-align: center;"><b>CAUTION</b></p> <p><b>Operation outside the permissible bearing temperature</b> Damage to the pump!</p> <ul style="list-style-type: none"> <li>▷ The bearing temperature of the pump (set) must never exceed 90 °C (measured on the outside of the bearing bracket).</li> </ul>
---	---

## 7.2.2 Inspection work

	<p><b>⚠ DANGER</b></p> <p><b>Excessive temperatures caused by friction, impact or frictional sparks</b>  Explosion hazard!  Fire hazard!  Damage to the pump set!</p> <ul style="list-style-type: none"> <li>▷ Regularly check the coupling guard, plastic components and other guards of rotating parts for deformation and sufficient distance from rotating parts.</li> </ul>
	<p><b>⚠ DANGER</b></p> <p><b>Static charging due to insufficient potential equalisation</b>  Explosion hazard!</p> <ul style="list-style-type: none"> <li>▷ Make sure that the connection between pump and baseplate is electrically conductive.</li> </ul>

## 7.2.2.1 Checking the coupling

Check the flexible elements of the coupling. Replace the relevant parts in due time if there is any sign of wear and check the alignment.

## 7.2.2.2 Checking the clearances

To check the clearances, remove the back pull-out unit.  
If the clearance is larger than permitted (see the following table), fit a new casing wear ring 502.1 and/or 502.2.  
The clearances specified refer to the impeller diameter.

**Table 18:** Clearances between impeller and casing / between impeller and casing wear ring

Pump sizes	CPKN-E CPKN-S	CPKN-C
150-630	0.6 mm	0.7 mm
200-670	0.6 mm	0.7 mm
250-630	0.75 mm	0.85 mm
250-710	0.6 mm	0.7 mm
300-630	0.75 mm	0.85 mm
300-710		
350-630	0.75 mm	0.85 mm
350-710		
400-504	0.75 mm	0.85 mm
400-506		
400-506		
400-630		
400-710		

For temperatures exceeding 250 °C, contact KSB.

	<p><b>NOTE</b></p> <p>If the clearances given are exceeded by more than 1 mm (referring to the diameter) replace the affected components or restore the original clearance by means of a casing wear ring.  Contact KSB.</p>
---	--

7.2.2.3 Cleaning filters

	<b>CAUTION</b>
	<p><b>Insufficient inlet pressure due to clogged filter in the suction line</b>                  Damage to the pump!</p> <ul style="list-style-type: none"> <li>▷ Monitor contamination of filter with suitable means (e.g. differential pressure gauge).</li> <li>▷ Clean filter at appropriate intervals.</li> </ul>

7.2.3 Lubrication and lubricant change of rolling element bearings

	<b>⚠ DANGER</b>
	<p><b>Excessive temperatures as a result of bearings running hot or defective bearing seals</b>                  Explosion hazard!                  Fire hazard!                  Damage to the pump set!</p> <ul style="list-style-type: none"> <li>▷ Regularly check the condition of the lubricant.</li> </ul>

7.2.3.1 Oil lubrication

The rolling element bearings are usually lubricated with mineral oil.

7.2.3.1.1 Intervals

Table 19: Oil change intervals

Temperature at the bearing	First oil change	All subsequent oil changes <sup>8)</sup>
up to 70 °C	After 300 operating hours	Every 8500 operating hours
70 °C - 80 °C	After 300 operating hours	Every 4200 operating hours
80 °C - 90 °C	After 300 operating hours	Every 2000 operating hours

7.2.3.1.2 Oil quality

Oil quality Table 20: Oil quality

Designation	Symbol to DIN 51502	Characteristics	
		CLP46 lubricating oil to DIN 51517 or HD 20W/20 SAE	□
Flash point (to Cleveland)	+175 °C		
Solidification point (pour point)	-15 °C		
Application temperature <sup>9)</sup>	Higher than permissible bearing temperature		

8) At least once a year



9) For ambient temperatures below -10 °C use a different suitable type of lubricating oil. Contact KSB.

7.2.3.1.3 Oil quantity

Table 21: Oil quantity

Bearing bracket	Oil quantity in l
P08s	4.5
P10as	4.0
P12s	4.0

7.2.3.1.4 Changing the oil

	 <b>WARNING</b>
	<p><b>Lubricants posing a health hazard and/or hot lubricants</b> Hazard to persons and the environment!</p> <ul style="list-style-type: none"> <li>▷ When draining the lubricant take appropriate measures to protect persons and the environment.</li> <li>▷ Wear safety clothing and a protective mask if required.</li> <li>▷ Collect and dispose of any lubricants.</li> <li>▷ Observe all legal regulations on the disposal of fluids posing a health hazard.</li> </ul>

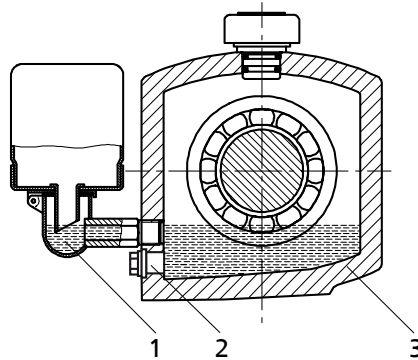



Fig. 13: Bearing bracket with constant level oiler

1	Constant level oiler	2	Screw plug
3	Bearing bracket		

- ✓ A suitable container for the used oil is on hand.
- 1. Place the container underneath the screw plug.
- 2. Undo the screw plug (2) at the bearing bracket (3) and drain the oil.
- 3. Once the bearing bracket (3) has been drained, re-insert and re-tighten the screw plug (2).
- 4. Re-fill with oil.

7.3 Drainage/cleaning

	 <b>WARNING</b>
	<p><b>Fluids handled, consumables and supplies which are hot and/or pose a health hazard</b> Hazard to persons and the environment!</p> <ul style="list-style-type: none"> <li>▷ Collect and properly dispose of flushing fluid and any fluid residues.</li> <li>▷ Wear safety clothing and a protective mask if required.</li> <li>▷ Observe all legal regulations on the disposal of fluids posing a health hazard.</li> </ul>

If the pump set has handled fluids whose residues could lead to corrosion damage in the presence of atmospheric humidity or could ignite upon contact with oxygen, the pump set must be neutralised, and anhydrous inert gas must be blown through the pump to ensure drying.

Use connection 6B to drain the fluid handled (see drawing of auxiliary connections).

### 7.4 Dismantling the pump set

#### 7.4.1 General information/Safety regulations

	<p> <b>WARNING</b></p>
	<p><b>Unqualified personnel performing work on the pump (set)</b> Risk of injury!</p> <ul style="list-style-type: none"> <li>▷ Always have repair work and maintenance work performed by specially trained, qualified personnel.</li> </ul>
	<p> <b>WARNING</b></p>
	<p><b>Hot surface</b> Risk of injury!</p> <ul style="list-style-type: none"> <li>▷ Allow the pump set to cool down to ambient temperature.</li> </ul>
	<p> <b>WARNING</b></p>
	<p><b>Improper lifting/moving of heavy assemblies or components</b> Personal injury and damage to property!</p> <ul style="list-style-type: none"> <li>▷ Use suitable transport devices, lifting equipment and lifting tackle to move heavy assemblies or components.</li> </ul>

Observe the general safety instructions and information. (⇒ Section 7.2, Page 42)

For any work on the motor, observe the instructions of the relevant motor manufacturer.

For dismantling and reassembly refer to the general assembly drawing. (⇒ Section 9.1, Page 61)

In the event of damage you can always contact our service departments.

	<p> <b>DANGER</b></p>
	<p><b>Insufficient preparation of work on the pump (set)</b> Risk of injury!</p> <ul style="list-style-type: none"> <li>▷ Properly shut down the pump set. (⇒ Section 6.1.12, Page 37)</li> <li>▷ Close the shut-off elements in the suction line and discharge line.</li> <li>▷ Drain the pump and release the pump pressure. (⇒ Section 7.3, Page 46)</li> <li>▷ Shut off any auxiliary feed lines.</li> <li>▷ Allow the pump set to cool down to ambient temperature.</li> </ul>

#### 7.4.2 Preparing the pump set

1. De-energise the pump set and secure it against unintentional start-up.
2. Disconnect and remove all auxiliary pipework.
3. Remove the coupling guard.
4. Remove the coupling spacer, if any.
5. Drain the oil. (⇒ Section 7.2.3.1.4, Page 46)

## 7.4.3 Removing the motor

	<b>NOTE</b>
	On pump sets with spacer-type couplings, the back pull-out unit can be removed while the motor remains bolted to the baseplate.

	<b>WARNING</b>
	<b>Motor tilting</b> Risk of crushing hands and feet! ▶ Suspend or support the motor to prevent it from tilting.

1. Disconnect the motor from the power supply.
2. Unbolt the motor from the baseplate.
3. Shift the motor to separate it from the pump.

## 7.4.4 Removing the back pull-out unit

- ✓ Pumps without spacer-type coupling: the motor has been removed.

	<b>WARNING</b>
	<b>Back pull-out unit tilting</b> Risk of crushing hands and feet! ▶ Suspend or support the bearing bracket at the pump end.

1. If required, suspend or support bearing bracket 330 to prevent it from tilting.
2. Unbolt support foot 183 from the baseplate.
3. Undo hexagon nut 920.01 at the volute casing.
4. Pull the back pull-out unit out of the volute casing.
5. Remove and dispose of joint ring 411.10.
6. Place the back pull-out unit on a clean and level surface.

## 7.4.5 Removing the impeller

**Bearing assembly P08s**

- ✓ The notes and steps stated in (⇒ Section 7.4.1, Page 47) to (⇒ Section 7.4.4, Page 48) have been observed/carried out.
- ✓ The back pull-out unit is kept in a clean and level assembly area.
  1. Undo impeller nut 922 (right-hand thread).
  2. Remove impeller 230 with an impeller removal device.
  3. Place impeller 230 on a clean and level surface.
  4. Remove keys 940.1 from shaft 210.
  5. Remove and dispose of joint rings 411.31/411.32.

**Bearing assemblies P10as/P12s**

- ✓ The notes and steps stated in (⇒ Section 7.4.1, Page 47) to (⇒ Section 7.4.4, Page 48) have been observed/carried out.
- ✓ The back pull-out unit is kept in a clean and level assembly area.
  1. Unscrew impeller hub cap 260.01 (right-hand thread).
  2. Bend open lockwasher 931.02, remove hexagon head bolt 901.87 with lockwasher 931.02 and disc 550.87.
  3. Remove impeller 230 with an impeller removal device.



4. Place impeller 230 on a clean and level surface.
5. Remove keys 940.1 from shaft 210.
6. Remove and dispose of joint rings 411.31/411.32.

### 7.4.6 Removing the shaft seal

#### 7.4.6.1 Removing the mechanical seal



- ✓ The notes and steps stated in (⇒ Section 7.4.1, Page 47) to (⇒ Section 7.4.5, Page 48) have been observed/carried out.
  - ✓ The back pull-out unit is kept in a clean and level assembly area.
1. Undo hexagon nuts 920.02 and push back seal cover 471 (if fitted) until it rests against thrower 507.01.
  2. Remove hexagon nut 920.03.
  3. Use forcing screws 901.34 to remove stuffing box housing 451.01 from casing cover 161.
  4. Undo socket head cap screws 914.04, if any, and remove neck bush 456.01.
  5. Pull the complete mechanical seal assembly with shaft protecting sleeve 524.01, seal cover 471.01 and thrower 507.01 off the shaft.
  6. If required, unscrew socket head cap screws 914.09 and use forcing screws to pull out angular casing wear ring 502.02.
  7. Remove hexagon nuts 920.15.
  8. Use forcing screws 901.31 to separate casing cover 161 from bearing bracket lantern 344.  
Lifting lugs can be screwed into the casing cover for transport.

#### 7.4.6.2 Dismantling the packed gland

- ✓ The notes and steps stated in (⇒ Section 7.4.1, Page 47) to (⇒ Section 7.4.5, Page 48) have been observed/carried out.
  - ✓ The back pull-out unit is kept in a clean and level assembly area.
1. Unscrew hexagon nuts 920.02 at gland follower 452 and remove the gland follower.
  2. Remove stuffing box ring 454.01 and drip plate 463.01.
  3. Remove hexagon nut 920.03.
  4. Use forcing screws to remove stuffing box housing 451.01 with the packed gland from casing cover 161.
  5. Remove packed gland 461.01 and lantern ring 458.01 from the packing chamber.
  6. Undo socket head cap screws 914.04, if any, and remove neck bush 456.01.
  7. If required, unscrew socket head cap screws 914.09 and use forcing screws to pull out angular casing wear ring 502.02.
  8. Remove hexagon nuts 920.15.
  9. Use forcing screws 901.31 to separate casing cover 161 from bearing bracket lantern 344.  
Lifting lugs can be screwed into the casing cover for transport.
  10. Pull off guard 680.
  11. Pull shaft protecting sleeve 524.01 and thrower 507.01 off shaft 210.

**7.4.7 Dismantling the bearings**



- ✓ The notes and steps stated in (⇒ Section 7.4.1, Page 47) to (⇒ Section 7.4.6, Page 49) have been observed/carried out.
- ✓ The bearing bracket has been placed in a clean and level assembly area.
  1. Unscrew hexagon nuts 920.04 at the flange of bearing bracket lantern 344.
  2. Remove bearing bracket lantern 344.
  3. Unscrew the hexagon socket head cap screw in the coupling hub.
  4. Pull the coupling half off the pump shaft with a puller.
  5. Remove key 940.02 and thrower 507.02.
  6. Undo screws 914.02 and remove drive-end bearing cover 360.02 and joint ring 400.02.
  7. Undo screws 914.01 and remove pump-end bearing cover 360.01 and joint ring 400.01.
  8. Carefully drive shaft 210 together with angular contact ball bearing 320.02 and the inner race of cylindrical roller bearing 322.01 out of the bearing bracket towards the drive end.
  9. Remove support disc 550.23 of angular contact ball bearing 320.02 from bearing bracket 330.
  10. Remove cylindrical roller bearing 322.01 (roller cage) from bearing bracket 330.
  11. Bend open lock washer 931.01 behind slotted round nut 920.21 on shaft 210.
  12. Unscrew slotted round nut 920.21 (right-hand thread) and remove lock washer 931.01.

	 <b>WARNING</b>
	<p><b>Hot surfaces due to heating of components for assembly/dismantling</b> Risk of burns!</p> <ul style="list-style-type: none"> <li>▷ Wear heat-resistant protective gloves.</li> <li>▷ Remove flammable substances from the danger zone.</li> </ul>

13. Heat up angular contact ball bearing 320.02 and the inner ring of cylindrical roller bearing 322.01 to 80 °C, and pull them off shaft 210.
14. Dispose of joint rings 400.01/02.

**7.5 Reassembling the pump set**

**7.5.1 General information/Safety regulations**

	 <b>WARNING</b>
	<p><b>Improper lifting/moving of heavy assemblies or components</b> Personal injury and damage to property!</p> <ul style="list-style-type: none"> <li>▷ Use suitable transport devices, lifting equipment and lifting tackle to move heavy assemblies or components.</li> </ul>

	<b>CAUTION</b>
	<p><b>Improper reassembly</b> Damage to the pump!</p> <ul style="list-style-type: none"> <li>▷ Reassemble the pump (set) in accordance with the general rules of sound engineering practice.</li> <li>▷ Use original spare parts only.</li> </ul>

**Sequence** Always reassemble the pump in accordance with the corresponding general assembly drawing.

- Sealing elements**
- **Gaskets**
    - Always use new gaskets, making sure that they have the same thickness as the old ones.
    - Always fit gaskets of asbestos-free materials or graphite without using lubricants (e.g. copper grease, graphite paste).
  - **O-rings**
    - Never use O-rings that have been made by cutting an O-ring cord to size and gluing the ends together.
  - **Packing rings**
    - Always use pre-compressed packing rings.

	<b>CAUTION</b>
	<p><b>Contact of O-ring with graphite or similar material</b>                  Fluid could escape!</p> <ul style="list-style-type: none"> <li>▷ Do not coat O-ring with graphite or similar material.</li> <li>▷ Use animal fats or lubricants based on silicone or PTFE.</li> </ul>

- **Assembly adhesives**
  - For gaskets, avoid the use of assembly adhesives if possible.
  - If assembly adhesives are required, use a commercially available contact adhesive (e.g. "Pattex").
  - Only apply adhesive at selected points and in thin layers.
  - Never use quick-setting adhesives (cyanoacrylate adhesives).
  - Coat the locating surfaces of the individual components and screwed connections with graphite or similar before reassembly.
  - Prior to reassembly, screw back any forcing screws and adjusting screws.

**Tightening torques** For reassembly, tighten all screws and bolts as specified in this manual.

**7.5.2 Installing the bearings**

- ✓ The individual parts have been placed in a clean and level assembly area.
- ✓ All dismantled parts have been cleaned and checked for wear.
- ✓ Any damaged or worn parts have been replaced by original spare parts.
- ✓ The sealing surfaces have been cleaned.

	<b>! WARNING</b>
	<p><b>Hot surfaces due to heating of components for assembly/dismantling</b>                  Risk of burns!</p> <ul style="list-style-type: none"> <li>▷ Wear heat-resistant protective gloves.</li> <li>▷ Remove flammable substances from the danger zone.</li> </ul>

1. Heat up angular contact ball bearing 320.02 and the inner ring of cylindrical roller bearing 322.01 to approx. 80 °C in an oil bath.
2. Slide angular contact ball bearing 320.02 and the inner ring of cylindrical roller bearing 322.01 onto shaft 210 until they will not go any further.

	<b>NOTE</b>
	<p>Angular contact ball bearings must be installed in back-to-back arrangement. Angular contact ball bearings installed in pairs must always be from the same manufacturer.</p>

3. Use a C-spanner to tighten slotted round nut 920.21 without lock washer 931.01.
4. Let angular contact ball bearing 320.01 cool down to approximately 5 °C above ambient temperature.
5. Re-tighten slotted round nut 920.21, then unscrew it again.
6. Apply a few spots of a suitable lubricant (e.g. Molykote) to the contact faces of lock washer 931.01 and slotted round nut 920.21.
7. Fit lock washer 931.01.
8. Tighten slotted round nut 920.21.
9. Bend back lock washer 931.01.
10. Insert circlip 932.01/932.02 into the bearing bracket.
11. Fit cylindrical roller bearing 322.01 (roller cage) in the bearing bracket.
12. Insert support disc 550.23 of angular contact ball bearing 320.02 into bearing bracket 330.
13. Carefully insert pre-assembled shaft 210 with angular contact ball bearing 320.02 and the inner ring of cylindrical roller bearing 322.01 into bearing bracket 330 from the drive end.
14. Fit pump-end bearing cover 360.01 with joint ring 400.01.
15. Fit drive-end bearing cover 360.02 with joint ring 400.02.
16. Fit bearing bracket lantern 344.
17. Tighten hexagon nut 920.04 at the flange of bearing bracket 330.
18. Fit keys 940.02.
19. Slide the coupling hub onto the shaft end.
20. Secure the coupling hub with an adjusting screw.
21. Fit thrower 507.01, if any.

### 7.5.3 Fitting the shaft seal

#### 7.5.3.1 Installing the mechanical seal

The following rules must be observed when installing the mechanical seal:

- For installing the mechanical seal, proceed as shown in the seal installation drawing.
- Work cleanly and accurately.
- Only remove the protective wrapping of the contact faces immediately before installation takes place.
- Prevent any damage to the sealing surfaces or O-rings.

- After inserting the stationary ring of the mechanical seal, check that it is plane-parallel in relation to the casing part.
  - The surface of the shaft protecting sleeve must be absolutely clean and smooth, and the sleeve's mounting edge must be chamfered.
  - When sliding the rotating assembly onto the shaft protecting sleeve, take appropriate steps to protect the surface of the shaft protecting sleeve from damage.
- ✓ The notes and steps stated in (⇒ Section 7.5.1, Page 50) to (⇒ Section 7.5.2, Page 51) have been observed/carried out.
  - ✓ The bearing assembly and the individual parts of mechanical seal 433 are kept in a clean and level assembly area.
  - ✓ All dismantled parts have been cleaned and checked for wear.
  - ✓ Any damaged or worn parts have been replaced by original spare parts.
  - ✓ The sealing surfaces have been cleaned.
1. Slide thrower 507.01 (if any) onto shaft 210 from the pump end.
  2. Fit stuffing box housing 451.01 with studs 902.03, hexagon nut 920.03 and gasket 411.09 in casing cover 161.
  3. Fasten seal cover 471 with inserted O-ring and the stationary ring of the mechanical seal to stuffing box housing 451.01 with studs 902.02 and hexagon nuts 920.02.
  4. Fasten pre-assembled casing cover 161 with stud 902.15 and hexagon nut 920.15 to bearing bracket lantern 344.
  5. Fit the rotating assembly of mechanical seal 433 on shaft protecting sleeve 524.01 (observe distance B - see Supplementary Sheet of the mechanical seal).
  6. Slide pre-assembled mechanical seal 433 and shaft protecting sleeve 524.01 onto shaft 210.

7.5.3.2 Packing the gland

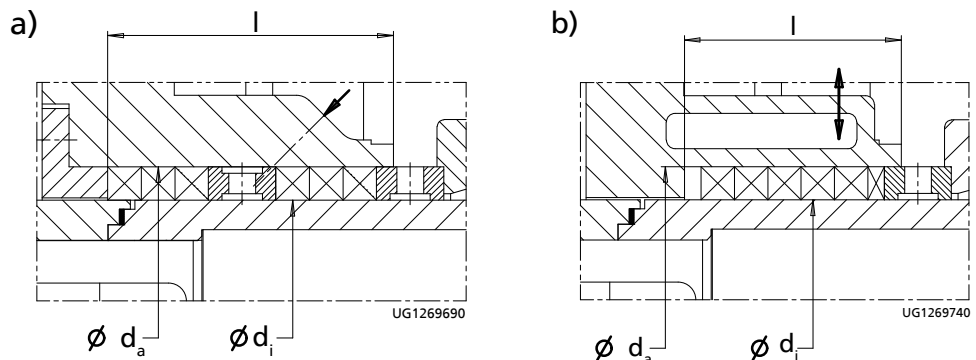

Fig. 14: Gland packing chamber a) uncooled and b) cooled, hot water

Stuffing box housing, uncooled

Table 22: Gland packing chamber - uncooled variant

Bearing bracket	Gland packing chamber			Packing cross-section	Packing rings
	Ø d <sub>i</sub>	Ø d <sub>a</sub>	l		
P08s	105	130	98	12,5 x 12,5	6 rings and 1 lantern ring
P10as	120	152	130	16 x 16	
P12s	140	172	130	16 x 16	

Stuffing box housing, cooled, hot water variant

Table 23: Gland packing chamber - cooled variant, hot water

Bearing bracket	Gland packing chamber			Packing cross-section	Packing rings
	Ø d <sub>i</sub>	Ø d <sub>a</sub>	l		
P08s	105	130	78	12,5 x 12,5	5 1/2 rings
P10as	120	152	105	16 x 16	
P12s	140	172	105	16 x 16	

Pure graphite packings see supplementary operating instructions.

Always use pre-compressed packing rings.

- ✓ The notes and steps stated in (⇒ Section 7.5.1, Page 50) to (⇒ Section 7.5.2, Page 51) have been observed/carried out.
  - ✓ The assembled bearing as well as the individual parts are kept in a clean and level assembly area.
  - ✓ All disassembled parts have been cleaned and checked for wear.
  - ✓ Any damaged or worn parts have been replaced by original spare parts.
  - ✓ The sealing surfaces have been cleaned.
1. Fasten pre-assembled casing cover 161 with stud 902.15 and hexagon nut 920.15 to bearing bracket lantern 344.
  2. Clamp stuffing box housing 451.01 into a vice.  
Fit neck bush 456.01, if any, with socket head cap screw 914.04.
  3. Insert the first packing ring, ensuring that its cut edge is in horizontal position.
  4. Hold the packing ring in place and slide shaft protecting sleeve 524 (chamfered side first) into the gland packing chamber from the pump end.
  5. Slightly expand the inside diameter of the packing ring by moving the shaft protecting sleeve back and forth. Then pull out shaft protecting sleeve 524. Insert lantern ring 458, if any (see drawing above).  
Insert each subsequent packing ring separately with its joint offset by approx. 90° in relation to the previous one. Repeat the expansion procedure.  
After inserting the last packing ring, shaft protecting sleeve 524 remains in the packing chamber.
  6. Insert stuffing box ring 454.01 with the drilled hole down.
  7. Fit gland follower 452 and lightly fasten it by hand with the two hexagon nuts 920.02; watch discs 550.01.
  8. Fit guard 680.
  9. Slide pre-assembled stuffing box housing 451.01 and shaft protecting sleeve 524.01 on the shaft and screw them to casing cover 161; take care not to damage gasket 411.09.

### 7.5.4 Fitting the impeller

#### Bearing assembly P08s:

- ✓ The notes and steps stated in (⇒ Section 7.5.1, Page 50) to (⇒ Section 7.5.3, Page 52) have been observed/carried out.
  - ✓ The assembled bearing/mechanical seal as well as the individual parts are kept in a clean and level assembly area.
  - ✓ All disassembled parts have been cleaned and checked for wear.
  - ✓ Any damaged or worn parts have been replaced by original spare parts.
  - ✓ The sealing surfaces have been cleaned.
  - ✓ Impeller bore, shaft and keyways are clean and free from burrs.
1. Insert keys 940.01 into the shaft keyway.
  2. Insert joint ring 411.32.
  3. Coat the impeller seat with a suitable lubricant.
  4. Slip impeller 230 onto shaft 210.
  5. Insert joint ring 411.31.
  6. Screw impeller nut 922 to shaft 210.  
Observe the tightening torques (⇒ Section 7.6.1, Page 56)

**Bearing assemblies P10as/P12s:**

- ✓ The notes and steps stated in (⇒ Section 7.5.1, Page 50) to (⇒ Section 7.5.3, Page 52) have been observed/carried out.
- ✓ The assembled bearing/mechanical seal as well as the individual parts are kept in a clean and level assembly area.
- ✓ All disassembled parts have been cleaned and checked for wear.
- ✓ Any damaged or worn parts have been replaced by original spare parts.
- ✓ The sealing surfaces have been cleaned.
- ✓ Impeller bore, shaft and keyways are clean and free from burrs.
  1. Insert keys 940.01 into the shaft keyway.
  2. Insert joint ring 411.32.
  3. Coat the impeller seat with a suitable lubricant.
  4. Slip impeller 230 onto shaft 210.
  5. Insert disc 550.87 into the impeller.
  6. Fit hexagon head bolt 901.87 with lockwasher 931.02.  
Observe the tightening torques (⇒ Section 7.6.1, Page 56)
  7. Bend back lockwasher 931.02.
  8. Fit impeller hub cap 260.01 with joint ring 412.03 on impeller 230.

**7.5.5 Fitting the back pull-out unit**

	<p><b>⚠ WARNING</b></p>
	<p><b>Back pull-out unit tilting</b> Risk of crushing hands and feet!</p> <ul style="list-style-type: none"> <li>▷ Suspend or support the bearing bracket at the pump end.</li> </ul>

- ✓ The notes and steps stated in (⇒ Section 7.5.1, Page 50) to (⇒ Section 7.5.4, Page 54) have been observed/carried out.
- ✓ Any damaged or worn parts have been replaced by original spare parts.
- ✓ The sealing surfaces have been cleaned.
- ✓ For back pull-out units supplied without coupling: Fit the coupling in accordance with the manufacturer's instructions.
  1. If required, suspend or support the back pull-out unit to prevent it from tilting. Then slide it into volute casing 102 with a new gasket 411.10.
  2. Tighten nut 920.01 at the volute casing.
  3. Bolt support foot 183 to the baseplate.

**7.5.6 Mounting the motor**

	<p><b>NOTE</b></p>
	<p>Steps 1 and 2 do not apply to versions with spacer-type coupling.</p>

1. Shift the motor to connect it to the pump via the coupling.
2. Fasten the motor to the baseplate.
3. Align pump and motor.
4. Connect the motor to the power supply (refer to manufacturer's product literature).

## 7.6 Tightening torques

### 7.6.1 Tightening torques

Use a torque wrench to tighten the bolted connections (902.01/920.01) between the volute casing and the bearing bracket lantern.

**Table 24:** Tightening torques [Nm] for screwed connections

Material of stud/ hexagon nut	1.7709+QT / 1.7258+QT			Monix3k / Monix3k			A4-70 / A4-70		
Stamp mark on stud/ hexagon nut <sup>10)</sup>	GA / G			MM / MM (M3k)			A4-70 / A4-70		
	Brand-new threads <sup>11)</sup>	-15 % <sup>12)</sup>	-20 % <sup>12)</sup>	Brand-new threads <sup>11)</sup>	-15 % <sup>12)</sup>	-20 % <sup>12)</sup>	Brand-new threads <sup>11)</sup>	-15 % <sup>12)</sup>	-20 % <sup>12)</sup>
M 16	190	162	152	320	272	256	155	132	124
M 20	330	281	264	620	527	496	200	170	160
M 24	570	485	456	900	765	720	270	230	215
M 30	1000	850	800	1200	1020	960	550	468	440

### 7.6.2 Tightening torques for impeller nut/impeller screw

**Bearing bracket P08s** Tighten the impeller nut to the following torques:

Bearing bracket	Tightening torques [Nm]	Width across flats [mm]
P08as	1000	60

Re-tighten the impeller nut some 20 to 30 minutes after assembly.

**Bearing brackets P10as and P12s** Tighten hexagon head bolt 901.87 to the following torques:

Bearing bracket	Tightening torques [Nm]	Hexagon head bolt 901.87
P10as	350	M 24
P12s	350	M 24

## 7.7 Spare parts stock

### 7.7.1 Ordering spare parts

Always quote the following data when ordering replacement or spare parts:

- Order number
- Order item number
- Type series
- Size
- Material variant
- Year of construction

Refer to the name plate for all data.

10) Treat unstamped screwed connections like material pair C35/E+QT/C 35.

11) These values are determined on the basis of a friction coefficient of  $\mu = 0.12$ .

12) After repeated tightening of the threads and in case of good lubrication the values shall be reduced by 15 to 20 %.



Also specify the following data:

- Part number and description
- Quantity of spare parts
- Shipping address
- Mode of dispatch (freight, mail, express freight, air freight)

**7.7.2 Recommended spare parts stock for 2 years' operation to DIN 24296**

**Table 25:** Quantity of spare parts for recommended spare parts stock

Part No.	Part description	Number of pumps (including stand-by pumps)						
		2	3	4	5	6 and 7	8 and 9	10 and more
210	Shaft	1	1	1	2	2	2	20 %
230	Impeller	1	1	1	2	2	2	20 %
320.02	Angular contact ball bearing (set)	1	1	2	2	2	3	25 %
322.01	Cylindrical roller bearing	1	1	2	2	2	3	25 %
502.01/02	Casing wear ring	4	4	6	6	2	3	30 %
503.01/02	Impeller wear ring							
524.01	Shaft protecting sleeve	2	2	2	3	3	4	50 %
-	Gaskets for pump casing (set)	4	6	8	8	9	12	150 %
-	Torque-transmitting coupling elements (set)	1	1	2	2	3	4	30 %
Variants with mechanical seal:								
433	Mechanical seal, complete	1	1	2	2	2	3	25 %
Variants with gland packing:								
461.01	Gland packing (set)	4	4	6	6	6	8	100 %
456.01	Neck bush	1	1	2	2	2	3	30 %

## 7.7.3 Interchangeability of pump components

Components featuring the same number in a column are interchangeable.



**NOTE**

Volute casing 102 and impeller 230 are not interchangeable between different pump sizes.

**Table 26:** Interchangeability of pump components

Bearing bracket	Pump size	Part description																	
		Casing cover	Support foot	Shaft	Impeller hub cap	Angular contact ball bearing	Cylindrical roller bearing	Bearing bracket	Bearing bracket lantern	Mechanical seal	Stuffing box housing	Seal cover	Casing wear ring	Casing wear ring	Thrower	Shaft protecting sleeve	Guard	Impeller screw	Impeller nut
		Part No.																	
		161	183	210	260.01	320.02	322.01	330	344	433	451.01	471.01	502.01	502.02	507.01	524.01	680	901.87	922
P08s	150-630	1	1	1	-	1	1	1	1	1	1	1	1	1	1	1	1	-	1
	200-670	2	1	1	-	1	1	1	2	1	1	1	2	1	1	1	1	-	1
P10as	250-630	3	2	2	1	2	2	2	2	2	2	2	3	2	2	2	-	1	-
	300-630	3	3	2	1	2	2	2	2	2	2	2	4	3	2	2	-	1	-
	400-504	4	4	2	1	2	2	2	1	2	2	2	5	4	2	2	-	1	-
	400-506	5	4	2	1	2	2	2	1	2	2	2	6	5	2	2	-	1	-
	250-710	6	3	2	1	2	2	2	2	2	2	2	7	6	2	2	-	1	-
	300-710	6	3	2	1	2	2	2	2	2	2	2	8	7	2	2	-	1	-
P12s	350-630	7	5	3	2	2	2	2	2	3	3	3	9	8	3	3	-	1	-
	400-630	7	5	3	2	2	2	2	2	3	3	3	10	9	3	3	-	1	-
	350-710	8	5	3	2	2	2	2	2	3	3	3	9	8	3	3	-	1	-
	400-710	8	4	3	2	2	2	2	2	3	3	3	10	9	3	3	-	1	-

## 8 Trouble-shooting

	 <b>WARNING</b>
	<p><b>Improper work to remedy faults</b></p> <p>Risk of injury!</p> <p>▷ For any work performed to remedy faults, observe the relevant information given in this operating manual and/or in the product literature provided by the accessories manufacturer.</p>

If problems occur that are not described in the following table, consultation with the KSB customer service is required.

- A Pump delivers insufficient flow rate
- B Motor is overloaded
- C Excessive discharge pressure
- D Increased bearing temperature
- E Leakage at the pump
- F Excessive leakage at the shaft seal
- G Vibrations during pump operation
- H Impermissible temperature increase in the pump

Table 27: Trouble-shooting

A	B	C	D	E	F	G	H	Possible cause	Remedy <sup>13)</sup>
X	-	-	-	-	-	-	-	Pump delivers against an excessively high pressure.	Re-adjust to duty point. Check system for impurities. Fit a larger impeller. <sup>14)</sup> Increase the speed (turbine, I.C. engine).
X	-	-	-	-	-	X	X	Pump or piping are not completely vented or primed.	Vent and/or prime.
X	-	-	-	-	-	-	-	Supply line or impeller clogged	Remove deposits in the pump and/or piping.
X	-	-	-	-	-	-	-	Formation of air pockets in the piping	Alter piping layout. Fit vent valve.
X	-	-	-	-	-	X	X	Suction lift is too high/NPSH <sub>available</sub> (positive suction head) is too low.	Check/alter fluid level. Install pump at a lower level. Fully open the shut-off element in the suction line. Change suction line, if the friction losses in the suction line are too high. Check any strainers installed/suction opening. Observe permissible speed of pressure fall.
X	-	-	-	-	-	-	-	Air intake at the shaft seal	Clean barrier fluid duct, supply external barrier fluid, if necessary, or increase barrier fluid pressure. Replace shaft seal.
X	-	-	-	-	-	-	-	Wrong direction of rotation	Check the electrical connection of the motor and the control system, if any.
X	-	-	-	-	-	-	-	Speed is too low. <sup>14)</sup> - Operation with frequency inverter - Operation without frequency inverter	- Increase voltage/frequency at the frequency inverter in the permissible range. - Check voltage.
X	-	-	-	-	-	X	-	Impeller	Replace worn components by new ones.
-	X	-	-	-	-	X	-	Pump back pressure is lower than specified in the purchase order.	Re-adjust to duty point. In the case of persistent overloading, turn down impeller. <sup>14)</sup>

13) Pump pressure must be released before attempting to remedy faults on parts which are subjected to pressure.

14) Contact KSB.

## 8 Trouble-shooting

A	B	C	D	E	F	G	H	Possible cause	Remedy <sup>13)</sup>
-	X	-	-	-	-	-	-	Density or viscosity of fluid handled higher than stated in purchase order	Contact KSB.
-	X	-	-	-	X	-	-	Gland follower over-tightened or cocked	Correct.
-	X	X	-	-	-	-	-	Speed is too high.	Reduce speed. <sup>14)</sup>
-	-	-	-	X	-	-	-	Defective gasket	Fit new gasket between volute casing and casing cover.
-	-	-	-	-	X	-	-	Worn shaft seal	Fit new shaft seal. Check flushing liquid/barrier fluid.
X	-	-	-	-	X	-	-	Score marks or roughness on shaft protecting sleeve / shaft sleeve	Replace shaft protecting sleeve/shaft sleeve. Fit new shaft seal.
-	-	-	-	-	X	-	-	Vibrations during pump operation	Correct suction conditions. Re-align the pump. Re-balance the impeller. Increase pressure at the pump suction nozzle.
-	-	-	X	-	X	X	-	The pump set is misaligned.	Re-align.
-	-	-	X	-	X	X	-	Pump is warped or sympathetic vibrations in the piping.	Check the piping connections and secure fixing of pump; if required, reduce distances between the pipe clamps. Fix the pipelines using anti-vibration material.
-	-	-	X	-	-	X	-	Insufficient or excessive quantity of lubricant or unsuitable lubricant.	Top up, reduce or change lubricant.
-	-	-	X	-	-	-	-	Non-compliance with specified coupling distance	Correct the distance according to general arrangement drawing.
X	X	-	-	-	-	-	-	Motor is running on two phases only.	Replace the defective fuse. Check the electric cable connections.
-	-	-	-	-	-	X	-	Rotor out of balance	Clean the impeller. Re-balance the impeller.
-	-	-	-	-	-	X	-	Defective bearing(s)	Replace.
-	-	-	-	-	-	X	X	Flow rate is too low.	Increase the minimum flow rate.
-	-	-	-	-	X	-	-	Incorrect inflow of circulation liquid	Increase the free cross-section.

## 9 Related Documents

### 9.1 General assembly drawing with list of components

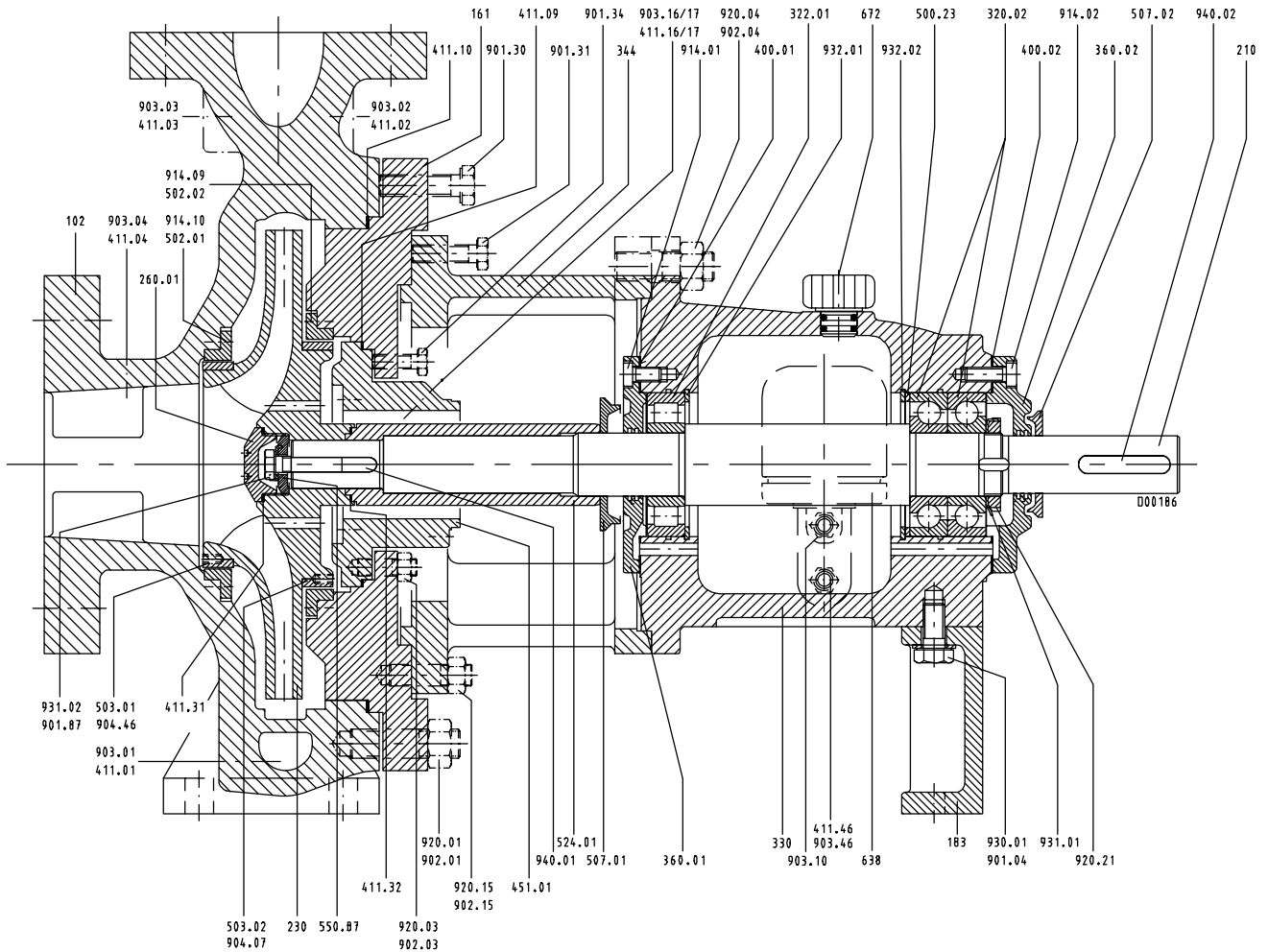

Fig. 15: General assembly drawing

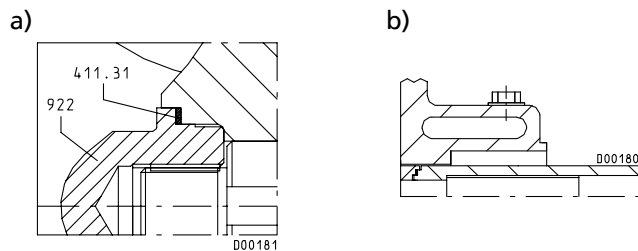

Fig. 16: a) Impeller fastening on bearing bracket P08s and b) Intensively cooled shaft seal chamber

Table 28: List of components

Part No.	Description	Scope of supply
102	Volute casing	with joint ring 411.01/10, casing wear ring 502.01, stud 902.01, screwed plug 903.01, socket head cap screw 914.10, hexagon nut 920.01
161	Casing cover	with joint ring 411.09, casing wear ring 502.02, stud 902.15, socket head cap screw 914.09, hexagon nut 920.15
183	Support foot	
210	Shaft	with keywayed nut 920.21, lockwasher 931.01, key 940.01/02
230	Impeller	with impeller wear ring 503.01/02 (if any)
260.01	Impeller hub cap	(bearing brackets P10as/P12s)
320.02	Angular contact ball bearing	

9 Related Documents

Part No.	Description	Scope of supply
322.01	Cylindrical roller bearing	
330	Bearing bracket	
344	Bearing bracket lantern	with stud 902.04, hexagon head bolt 920.04
360.01/02	Bearing cover	
451.01	Stuffing box housing	with stud 902.03, screwed plug 903.16/.17, hexagon nut 920.03
502.01/.02	Casing wear ring	
507.01/.02	Thrower	
524.01	Shaft protecting sleeve	
550.23	Support disc	
550.87	Disc	(bearing brackets P10as, P12s)
638	Constant-level oiler	
672	Vent plug	
901.04	Hexagon head bolt	
901.87	Hexagon head bolt	
903.46	Screwed plug	
914.01/.02	Socket head cap screw	
914.09/.10	Socket head cap screw	
922	Impeller nut	(bearing bracket P08s)
930.01	Spring washer	
931.01	Lockwasher	
931.02	Lockwasher	(bearing brackets P10as, P12s)
932.01/.02	Circlip	

## 10 EU Declaration of Conformity

Manufacturer: **KSB SE & Co. KGaA**  
**Johann-Klein-Straße 9**  
**67227 Frankenthal (Germany)**

The manufacturer herewith declares that the product:

### **CPKN, CPKNO, CPKN-CHs**

KSB order number: .....

- is in conformity with the provisions of the following Directives as amended from time to time:
  - Pump (set): Machinery Directive 2006/42/EC

The manufacturer also declares that

- the following harmonised international standards have been applied:
  - ISO 12100
  - EN 809
- Applied national technical standards and specifications, in particular:
  - DIN EN ISO 5199

Person authorised to compile the technical file:

Name  
Function  
Address (company)  
Address (Street, No.)  
Address (post or ZIP code, city) (country)

The EU Declaration of Conformity was issued in/on:

Place, date

.....<sup>15)</sup>.....

Name  
Function  
Company  
Address

---

15) A signed, legally binding EU Declaration of Conformity is supplied with the product.

---

## 11 Certificate of Decontamination

Type: .....

Order number/ .....

Order item number<sup>16)</sup>: .....

Delivery date: .....

Field of application: .....

Fluid handled<sup>16)</sup>: .....

Please tick where applicable<sup>16)</sup>:



Radioactive



Explosive



Corrosive



Toxic



Harmful



Bio-hazardous



Highly flammable



Safe

Reason for return<sup>16)</sup>: .....

Comments: .....

.....

The product/accessories have been carefully drained, cleaned and decontaminated inside and outside prior to dispatch/ placing at your disposal.

We herewith declare that this product is free from hazardous chemicals, biological and radioactive substances.

For mag-drive pumps, the inner rotor unit (impeller, casing cover, bearing ring carrier, plain bearing, inner rotor) has been removed from the pump and cleaned. In cases of containment shroud leakage, the outer rotor, bearing bracket lantern, leakage barrier and bearing bracket or adapter have also been cleaned.

For canned motor pumps, the rotor and plain bearing have been removed from the pump for cleaning. In cases of leakage at the stator can, the stator space has been examined for fluid leakage; if fluid handled has penetrated the stator space, it has been removed.

- No special safety precautions are required for further handling.
- The following safety precautions are required for flushing fluids, fluid residues and disposal:

.....

.....

We confirm that the above data and information are correct and complete and that dispatch is effected in accordance with the relevant legal provisions.

.....

Place, date and signature

.....

Address

.....

Company stamp

16) Required fields



## Index

### A

Abrasive fluids 39  
Auxiliary connections 26

### B

Bearing temperature 43  
Bearings 17

### C

Certificate of decontamination 64  
Clearance gaps 44  
Clearances 44  
Commissioning 31  
Configuration 18  
Constant level oiler 31  
Contact guard 20  
Coupling 20, 44  
Coupling alignment 27

### D

Design 16  
Designation 16  
Direction of rotation 30  
Disassembly 47  
Disposal 15  
Drive 19

### E

Event of damage 7  
    Ordering spare parts 56  
Explosion protection 11, 21, 26, 28, 29, 30, 33, 35, 37,  
38, 41, 42, 43, 44, 45

### F

Faults  
    Causes and remedies 59  
Fields of application 9  
Filter 24, 45  
Final check 33  
Flow rate 38  
Fluid handled  
    Density 39  
Frequency of starts 38  
Function 18

### G

General assembly drawing 61  
Gland packing 36

### H

Heating speed 34  
Heating up 34

### I

Impeller type 17  
Installation  
    Installation on a foundation 22  
Installation at site 21  
Intended use 9  
Interchangeability of pump components 58

### K

Keeping warm 34  
Key to safety symbols/markings 8

### L

Leakage rate 36

### M

Maintenance 42  
Mechanical seal 36  
Monitoring equipment 12

### N

Name plate 16  
Noise characteristics 19

### O

Oil lubrication  
    Intervals 45  
    Oil quality 45  
    Oil quantity 46  
Operating limits 37  
Order number 7  
Other applicable documents 7

### P

Partly completed machinery 7  
Permissible forces and moments at the pump  
nozzles 24  
Piping 23  
Preservation 14, 40  
Priming and venting 33  
Product description 16  
Pump casing 17  
Pure graphite packing 36

## R

Return to supplier 14  
Returning to service 40  
Running noises 42, 43

## S

Safety 9  
Safety awareness 10  
Scope of supply 19  
Shaft seal 17  
Shutdown 37, 40  
Spare part  
    Ordering spare parts 56  
Spare parts stock 57  
Special accessories 20  
Start-up 35  
Storage 14, 40

## T

Temperature difference 35  
Temperature limits 11, 12  
Tightening torques 56  
Transport 13

## W

Warnings 8  
Warranty claims 7  
Water cooling 34



**Ksb. IRAN**

**[www.ksbiran.com](http://www.ksbiran.com)**